

CATALOGUE 2006/2008



CAFE COLLECTIVITÉS

kitchen

cuisine

dining room

salle à manger

restaurant

restaurant

cafe

café

*Friendly chairs for every room
Un mobilier adapté à chaque intérieur*

KONTORSENTRET
MODERNE STÅLKONTORER A/S
Tlf: 22281580 E-mail: post@msk1.no

KONTORSENTRET MODERNE STÅLKONTORER A/S

Firmaet ble etablert i 1963 som et import/ grossist firma innen kontorutstyr. Siden den gang har vi etablert et solid forhandlernet i Norge. Vi representerer i dag noen av Europas ledende produsenter. Dette kommer deg som kunde til gode, både når det gjelder pris og kvalitet. Våre forhandlere sørger for god lokal service. Vi har spesialisert oss innen stoler, bord, arkivsystemer og garderober.



KONTORSENTRET MODERNE STÅLKONTORER AS

Detta selskapet er blant 3450 norske bedrifter som kan kalles seg «Gaselle-bedrift» i 2007.

For å komme på DNs Gaselleliste, søkert på list fra Dns & Bedriftret, må bedriften de siste fire år ha:

- omsetning over en million kroner.
- lavert gjeldsrente regnskaper.
- minst dobbel omsetningsvekst.
- positivt samlet driftsresultat.
- ansettelsesvekst hvert år.

Arne Mørse
Generaldirektør

Ulfen Bødal
Sjef

DagensNæringsliv

DNBNOR BDO NORASIT K&I



KONTORSENTRET MODERNE STÅLKONTORER AS

Detta selskapet er blant 4450 norske bedrifter som kan kalles seg «Gaselle-bedrift» i 2006.

For å komme på DNs Gaselleliste, søkert på list fra Dns & Bedriftret, må bedriften de siste fire år ha:

- omsetning over 10 millioner kroner.
- lavert gjeldsrente regnskaper.
- minst dobbel omsetningsvekst.
- positivt samlet driftsresultat.
- ansettelsesvekst hvert år.

Arne Mørse
Generaldirektør

Ulfen Bødal
Sjef

DagensNæringsliv

DNBNOR BDO NORASIT K&I

For andre år på rad ble vi en Gaselle bedrift, din trygghet for å ha valgt rett leverandør!



Abo ut the c o m p a n y / N o t r e s o c i e t é
Navigator | mode d'emploi

page 4 - 9
page 10 - 11

Chairs / Sièges

page 12 - 133

contents | contenu
wood + upholstery | bois + tapisserie
upholstery | tapisserie
wood + upholstery + metal | bois + tapisserie + métal
wood + metal | bois + métal
upholstery + metal | tapisserie + métal
plastic + upholstery + metal | plastique + tapisserie + métal
plastic + metal | plastique + métal

page 14 - 17
page 18 - 21
page 22 - 23
page 24 - 63
page 64 - 83
page 84 - 123
page 124 - 127
page 128 - 133

Bar stools / Tabourets de bar

page 134 - 181

contents | contenu
wood + upholstery + metal | bois + tapisserie + métal
wood + metal | bois + métal
upholstery + metal | tapisserie + métal

page 136 - 137
page 138 - 157
page 158 - 161
page 162 - 181

Stools / Tabourets

page 182 - 191

wood + metal | bois + métal
wood + upholstery + metal | bois + tapisserie + métal
upholstery + metal | tapisserie + métal

page 184 - 187
page 188 - 189
page 190 - 191

Tables / Tables

page 192 - 227

contents | contenu
wood | bois
wood + metal | bois + métal
metal | métal

page 194 - 195
page 196 - 197
page 198 - 199
page 200 - 227

Accessories / Accessoires

page 228 - 234

KONTORSENTRET

ONWARD, EVER ONWARD!

Chairs are with us at every stage of our lives. Well aware of this, for 14 years now we have been creating our functionally and aesthetically varied collections of chairs with nothing less than true passion. The thread that runs unerringly through each one is proven quality and reasonable price. We have now sold over 40 million chairs since our foundation, and you will come across them in 60 countries throughout the world. It affords us great satisfaction to know that our chairs are trusted both on the Polish market and on the international arena.

Our seating solutions are being chosen for increasing numbers of important events – at the 2004 Athens Olympics, for instance, there were 50,000 of our chairs at the disposal of competitors, journalists and spectators in several different venues. Before that, we seated the delegates to the G8 summit in Evian, and the audience and finalists of the 2003 MissWorld contest in Panama. Our chairs are used by French postal workers, the Hungarian and Cuban authorities, and Japanese businessmen. In May 2005, our products were appreciated by the participants in the Council of Europe summit, held in Warsaw; other new clients last year included a vast new shopping mall in Saudi Arabia, and sailors on several ships built in Spain. Chairs from Krosno will also shortly be at the service of pilgrims to the Sanctuary of Divine Mercy in Australia.



EVERY CHAIR A WORK OF ART!

A well designed chair guarantees ergonomic working conditions and comfortable relaxation. It can also be a unique accessory enhancing any interior. With this in mind, we treat every chair, from the drawing-board through launch of production to selection of the type and colour of the finish, with the care befitting a work of art.



 UNIQUE
DESIGN



 UNIQUE
DESIGN

THE QUALITY OF THE CHAIR IS THE QUALITY OF ITS PARTS



*Our chairs are manufactured to
ISO 9001:2000 quality standard*

Impeccable quality is a guarantee that your furniture will serve you long and faithfully, and for us that is a condition of your satisfaction. The durability of items that bear our name is monitored at every stage of production, from the prototype onwards. All the processes we employ conform to European standards (EN) and American norms (ANSI BIFMA). Tests on our products required for the GS Safety Symbol are conducted in our own R&D laboratory, and other checks are performed by independent national and international laboratories.

High-quality materials and laboratory testing guarantee the sturdiness of the metal parts. A protective coating of nickel and chrome or lacquer is applied to the metal components of our chairs in our own state-of-the-art chrome-plating shop. The matt or gloss chrome and lacquer accents add a long-lasting decorative touch to our chairs.

The wooden parts of our chairs are made from carefully selected solid wood and veneer. Quality assurance starts with the storage of the wood, with particular attention being paid to the parameters according to which it is dressed. Care continues throughout the production process up to the final coat of varnish. We are one of a very small group of manufacturers of a unique, first-class type of veneer, which we use in the production of our chairs. In order to guarantee invariably high quality, the entire wood processing line is computer controlled.

The upholstery fabrics we use to cover the soft sections of our chairs conform to the German DIN, the British BS series and the European EN standards. These regulate resistance to wear, flame and cigarette burns. The coverings we use on our chairs are non-toxic and environmentally friendly – they are biodegradable.



The product line category (based on types of finishes).
Informations concernant la catégorie de cette ligne de produits

wood + upholstery + metal / bois + tapisserie + métal



Finishes of products in the picture.
Types de finitions disponibles pour les produits présentés sur la photo.

Finishing used at the arrangement:
chairs wood 1.008, chairs
Dorino table wood 1.008

Finitions présentées dans cette page:
chairs bois 1.008, chaise
Dorino table bois 1.008

Dorino Duo
page 270



Information on other products in the photo.
Se rendre à la page indiquée dans le cadre pour plus d'information sur le modèle présenté.

The Dorino line consists of:
Ligne Dorino composée de:



Dorino
chairs presented on this page
chairs presented on this page

Dorino table
page 270

Dorino Duo table
page 269

Other products of the line.
Ensemble des produits composant la gamme.

36

NAVIGATOR MODE D'EMPLOI

Chairs with a chromed-plated and powder coated metal frame, with a plywood seat and backrest shell.
Also available with a wall-attached seat and backrest in plus version.
Chaises avec structure en métal chromé ou époxy avec assise rembourrée tapissée et dossier en bois massif.

Dorino

Design / Projet: Malgorzata P. Jula, Agata Danilak-Rydz



Chairs | Sièges

Detailed information on the product.
Descriptif détaillé de la ligne de produits présentée.

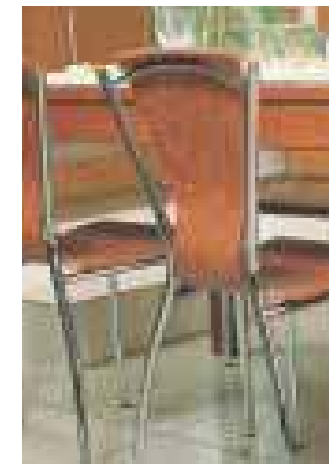

Finishing used at the arrangement:
chairs wood 1.002, etc.

Finitions présentées dans cette page:
chairs bois 1.002, etc.



New - refers to new products
Nouveauté - indique les nouveaux produits de notre offre.

Unique design - refers to products created by recognised designers exclusively for our company

The main product of the line.
Produit principal.

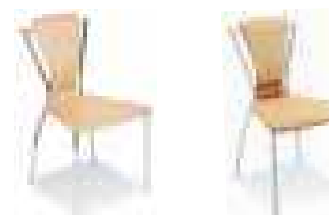

Dorino chrome

Dorino alu plus

The colour of metal finishes.
Type de finitions disponibles pour les piètements de sièges et tables.

Metal elements
Finitions tubes

alu

chrome

Dimensions of the product (in mm).
Dimensions du produit en millimètres.



Copyright © Neop Styl

KONTORSENTRET

37

CHAIRS
SIÈGES



Ordre alphabétique

CONTENT SYNTHÈSE



Alerto
page 120



Anaro
page 118 **NEW**



Amigo
page 128



Anca
page 58



Arancia
page 100



Argento
page 112 **NEW**



Ascona
page 122



Azzurro
page 102



Baleno
page 50 **NEW**



Beta
page 124



Bingo
page 32



Bistro
page 38

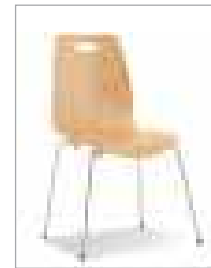

Cafe II
page 74



Cafe III
page 76

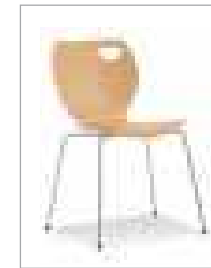

Cafe IV
page 78

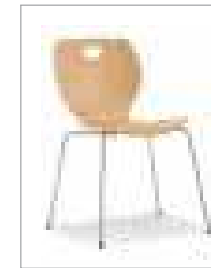

Cafe V
page 80



Cafe VI
page 40



Cafe VII
page 82



Caldo
page 92 **NEW**



Castano
page 116 **NEW**



Club
page 22



Cortina
page 130



Deco
page 56



Dolce
page 48 **NEW**



Dolly
page 68



Dorino
page 36



Elva
page 20



Fiamma
page 44 **NEW**



Fosca
page 54



Giallo
page 108



Golf
page 132



Grigio
page 98

Alphabetical order / Ordre alphabétique

CONTENT SYNTHESE



Harlekin
page 18



Ibis
page 86



Kelly
page 88

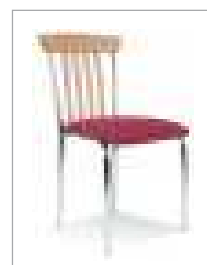

Koliber
page 34



Malva
page 20



Marino
page 114 **NEW**



Medea
page 70



Mewa
page 30



Molino
page 46



Neron
page 110

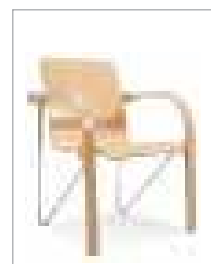

Plenum
page 26



Polyfold
page 126



Ristretto
page 72



Rosso
page 106



Salsa
page 24



SalsaWood
page 66



Samba
page 84



SambaWood
page 64



Tiziano
page 90 **NEW**



Tilipan
page 62



Vega
page 52



Vena
page 104



Vento
page 42 **NEW**



Venus
page 60



Visa
page 94



Wing II
page 28



Zeus
page 96



Finishings used at the arrangement:
chairs: wood 1.010, upholstery EF-019
Harlekin Table: wood 1.010

Finitions présentées dans cette page:
sièges: bois 1.010, tapisserie EF-019
Harlekin Table: bois 1.010

The Harlekin line consists of:
Ligne Harlekin composée de:



Harlekin Chair

Harlekin

Harlekin Table

page 196



Stacking / Empilabilité
max 4 pieces / maximum 4 pièces

Stacking / Empilabilité
max 4 pieces / maximum 4 pièces

Armchairs and chairs with a wooden frame and soft upholstered seat and backrest, with wooden armrests in the arm and Chair arm versions.

Sièges et fauteuils avec structure en bois, assise et dossier rembourrés tapissés. Accotoirs en bois sur les versions "arm" et "Chair arm".

Harlekin

Design | Projet: hermann + stupp • ulm



Harlekin Table
page 196



Harlekin

Harlekin arm

Harlekin Chair

Harlekin Chair arm

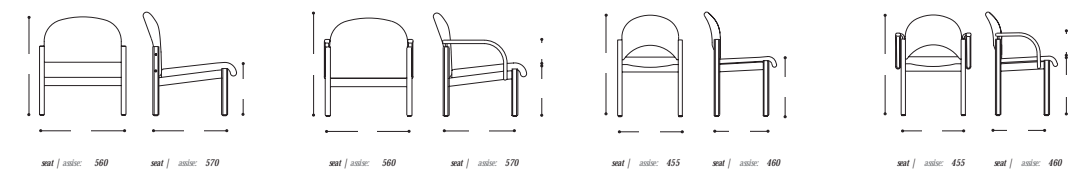

seat | assise: 560 seat | assise: 570

seat | assise: 560 seat | assise: 570

seat | assise: 455 seat | assise: 460

seat | assise: 455 seat | assise: 460

wood + upholstery

/ bois + tapisserie



Finishings used at the arrangement:
 chairs: wood 1.007, upholstery NV03
 Bistro Table: chrome
 table top: werzalit® W055, Ø 60 cm

Finitions présentées dans cette page:
 sièges: bois 1.007, tapisserie NV03
 Bistro Table: chrome
 plateau: werzalit® W055, Ø 60 cm

Bistro Table
 page 204



Eva - a chair with wooden frame with soft upholstered seat and backrest, and wooden armrests
 Malva - a chair with wooden frame and with soft upholstered seat and backrest.
 Eva - sièges avec structure et accotoirs bois, assise et dossier rembourrés tapissés.
 Malva - sièges avec structure bois, assise et dossier rembourrés tapissés.

Elva, Malva



Eva

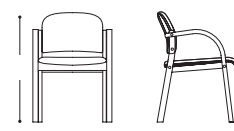

seat / assise: 475 seat / assise: 475



Stacking / Empilabilité
 max 4 pieces / maximum 4 pièces



Malva



seat / assise: 475 seat / assise: 475



Finisings used at the arrangement:
chairs: upholstery V27
table Dona-3: chrome
table top: werzalit: W055, Ø 60 cm

Finitions présentées dans cette page:
sièges: tapisserie V27
table Dona-3: chrome
plateau: werzalit: W055, Ø 60 cm

Dona-3
page 218



An armchair wholly upholstered in leather imitation or fabrics
Fauteuil entièrement tapissé, en similicuir ou tissu au choix.

Club



The Club line consists of:
Ligne Club composée de:



Club

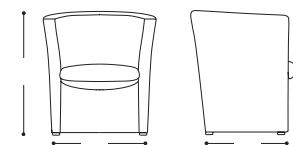

seat / backrest: 400 seat / backrest: 490



Club Duo

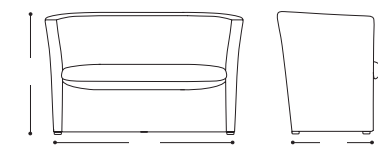

seat / backrest: 1066 seat / backrest: 490

wood + upholstery + metal

/ bois + tapisserie + métal

Salsa

A chair with a chromium plated or powder coated metal frame, with soft upholstered seat and backrest shell and wooden armrests. The Salsa-link allows linking Salsa chairs in rows.

Siège avec structure en métal époxy ou chromé, assise et dossier rembourrés tapissés et accotoirs bois. En option, pièce de liaison Salsa-link permettant d'aligner les sièges.



Finishings used at the arrangement:
chairs: wood 1.031, upholstery SE-09, chrome
table Sonia 840: chrome
table top: transparent glass, Ø 90 cm

Finitions présentées dans cette page:
sièges: bois 1.031, tapisserie SE-09, chrome
table Sonia 840: chrome
plateau: verre transparent, Ø 90 cm

Sonia
page 215



The Salsa line consists of:
Ligne Salsa composée de:



Salsa

presented on this page
sièges présentés sur cette page



Salsa Wood

page 66



Salsa link

for more information see_CAFE price list
complément d'information Nous consulter



Salsa chrome



Stacking / Empilabilité
max 4 pieces / maximum 4 pièces

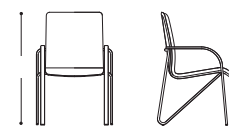

seat / assise: 400



seat / assise: 430

Metal elements
Finition tubes

alu

chrome



wood + upholstery + metal

/ bois + tapisserie + métal

A chair with a chromium plated or powder coated metal frame, with plywood seat and backrest shell and wooden armrests. The plus version has a soft upholstered seat and backrest. Click frame version allows linking Plenum chairs in rows.

Siège avec structure en métal époxy ou chromé, assise et dossier en hêtre multipli. En version "plus" - assise et dossier rembourrés tapissés. En version "click", structure intégrant un système de connexion pour aligner les sièges.

Plenum

Design / Projet: Kolibri Egnestuen
on license of DUBA / sous licence avec la société DUBA



Finishings used at the arrangement:
chairs: wood 1.007
table Lena: chrome
table top: werzalit-W074, Ø 60 cm

Finitions présentées dans cette page:
sièges: bois 1.007
table Lena: chrome
plateau: werzalit-W074, Ø 60 cm

Lena
page 224



The Plenum line consists of:
Ligne Plenum composée de:



Plenum

presented on this page
sièges présentés sur cette page



Plenum link

for more information see_CAFE price list
complément d'information Nous consulter



Plenum chrome



Plenum chrome plus



Stacking/Empilabilité
max 4 pieces/ maximum 4 pièces

Metal elements
Finition tubes

alu

chrome

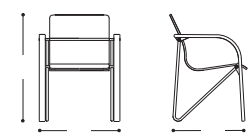

seat | assise: 443

seat | assise: 440

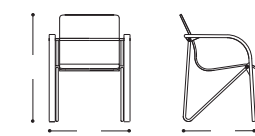

seat | assise: 443

seat | assise: 440



wood + upholstery + metal

/ bois + tapisserie + métal

Wing II

Design / Projet: Jens Korte

A chair with a chromium plated or powder coated metal frame, with a plywood seat and backrest shell. The seat plus version has a soft upholstered seat, the plus version has an upholstered seat and backrest. Click frame version allows linking Wing II chairs in rows.

Siège avec structure en métal époxy ou chromé, assise et dossier en hêtre multipli. En version "plus" - assise et dossier rembourrés tapissés. En version "seat plus" - assise rembourrée tapissée. En version "click" - structure intégrant un système de connexion pour aligner les sièges.



Algeo Table
from Stylistica collection



Finisings used at the arrangement:
chairs: wood 1.008, upholstery V15, chrome
Finitions présentées dans cette page:
sièges: bois 1.008, tapisserie V15, chrome

The Wing II line consists of:
Ligne Wing II composée de:



Wing II

Wing II link

Wing II CF

presented on this page
sièges présentés sur cette page

for more information see „CAFE“ price list
complément d'information Nous consulter

for more information see our „OFFICE“ catalogue
complément d'information sur les pièces
de liaison des sièges: catalogue „OFFICE“



Stacking / Empilabilité
max 8 pieces / maximum 8 pièces



Wing II chrome seat plus



seat / assise: 420 seat / assise: 440



Wing II chrome



seat / assise: 420 seat / assise: 440



Wing II.20 chrome



seat / assise: 420 seat / assise: 440



Wing II chrome plus



seat / assise: 420 seat / assise: 440

Metal elements
Finition tubes

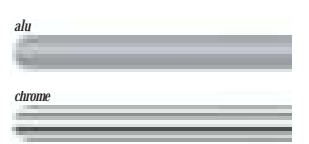

wood + upholstery + metal

| bois + tapisserie + métal



Finishings used at the arrangement:
 chairs: wood 1.008, upholstery SE-08, alu
 table Tracy: alu
 table top: **werzalit**™ W074, 80x80 cm

Finitions présentées dans cette page:
 sièges: bois 1.008, tapisserie SE-08, époxy aluminium
 table Tracy: époxy aluminium
 plateau: **werzalit**™ W074, 80x80 cm

Tracy
 page 210



A chair with a chromium plated or powder coated metal frame, soft upholstered seat and solid wooden backrest, back legs and armrest pads.

Siège avec structure chromée ou époxy; assise rembourrée tapissée.
 Dossier 2 pieds arrière et accotoirs en bois massif.



Finishings used at the arrangement:
 chairs: wood 1.007, upholstery SE-09, chrome
 Finitions présentées dans cette page:
 sièges : bois 1.007, tapisserie SE-09, chrome



Mewa alu



Mewa chrome

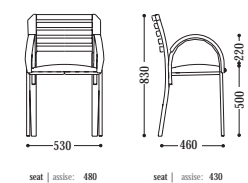

seat | assise: 480

seat | assise: 430

Mewa

Design | Projet: Paolo Galeotti
 all rights reserved | modèle exclusif



Metal elements
 Finition tubes

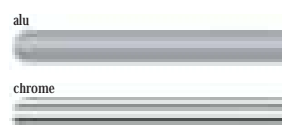

wood + upholstery + metal

| bois + tapisserie + métal



Finishings used at the arrangement:
chairs: wood 3.093, chrome
Finitions présentées dans cette page:
sièges: bois 3.093, chrome

The Bingo line consists of:
Ligne Bingo composée de:



Bingo

presented on this page
sièges présentés sur cette page



Bingo link

for more information see „CAFE“ price list
complément d'information Nous consulter



Bingo-3

for more information see our
„OFFICE“ catalogue
complément d'information sur les pièces
de liaison des sièges catalogue „OFFICE“



Bingo GTP

for more information see our
„OFFICE“ catalogue
complément d'information sur les pièces
de liaison des sièges catalogue „OFFICE“



Stacking | Empilabilité
max 4 pieces / maximum 4 pièces



Stacking | Empilabilité
max 4 pieces / maximum 4 pièces



Bingo wood chrome



Bingo wood chrome seat plus



Bingo wood chrome plus



Bingo arm wood chrome

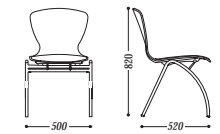

seat | assise: 445

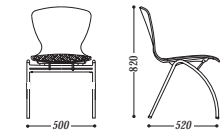

seat | assise: 455

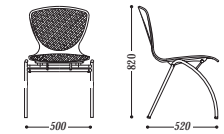

seat | assise: 445

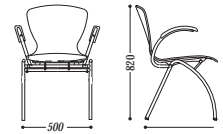

seat | assise: 445

Metal elements
Finition tubes



Modern Bible
from Stylistika collection



A chair with a chromium plated or powder coated metal frame, with a plywood seat and backrest shell.
Also available with a soft upholstered seat in seat plus version and with soft upholstered seat and backrest in plus version. The line is completed with swivel chairs and benches.
Siège avec structure en métal chromé ou époxy avec assise et dossier en hêtre multipli.
En version "arm", accotoirs en bois. En version "seat plus", assise rembourrée tapissée.
En version "plus", assise et dossier rembourrés tapissés.

Bingo

Design | Projet: hermann + stumpf • ulm
all rights reserved | modèle exclusif



wood + upholstery + metal

/ bois + tapisserie + métal



Finishings used at the arrangement:
chairs: wood 1.010, upholstery SE-08, alu

Finitions présentées dans cette page:
sièges: bois 1.010, tapisserie SE-08, alu

Catalonia
from Stylistica

Eble
collection



A chair with a chromium plated or powder coated metal frame,
soft upholstered seat and solid wooden backrest.

Siège avec structure en métal chromé ou époxy,
avec assise rembourrée tapissée et dossier en bois massif.

Koliber

Design / Projet: Paolo Galotti
all rights reserved / modèle exclusif



Finishings used at the arrangement:
chairs: wood 1.031, upholstery V-18, chrome
Dolly Eble 380: chrome
table top: werzalit® W011, Ø 90 cm

Finitions présentées dans cette page:
sièges: bois 1.031, tapisserie V-18, chrome
Dolly Eble 380: chrome
platon: werzalit® W011, Ø 90 cm

Dolly Eble 380
page 212



Koliber chrome



Koliber alu

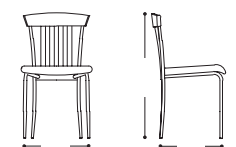

seat | assise: 460

seat | assise: 420

Metal elements
Finition tubes



wood + upholstery + metal

| bois + tapisserie + métal

A chair with a chromium plated and powder coated metal frame, with a plywood seat and backrest shell.
Also available with a soft upholstered seat and backrest in plus version.

Siège avec structure en métal chromé ou époxy,
avec assise rembourrée tapissée et dossier en bois massif

Dorino

Design | Projet: Malgorzata Pe kala, Agata Danielak-Kujda



Finishings used at the arrangement:
chairs: wood 1.010, chrome

Finitions présentées dans cette page:
sièges: bois 1.010, chrome



Finishings used at the arrangement:
chairs: wood 1.033, alu
Dorino Eble: wood 1.033, alu

Finitions présentées dans cette page:
sièges: bois 1.033, alu
Dorino Eble: bois 1.033, alu

Dorino Duo Eble
page 200



The Dorino line consists of:
Ligne Dorino composée de:



Dorino

presented on this page
sièges présentés sur cette page



Dorino Eble

page 200



Dorino Duo Eble

page 200



Dorino chrome

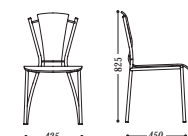

mat | antrac: 450 mat | antrac: 405



Dorino alu plus



mat | antrac: 450 mat | antrac: 405

Metal elements
Finition tubes



wood + upholstery + metal

/ bois + tapisserie + métal

A chair with a chromium plated or powder coated metal frame, and a plywood seat and backrest. Also available with a soft upholstered seat in plus version.

Sièges avec structure en métal chromé ou époxy avec assise et dossier en hêtre multipli. En version "plus", assise rembourrée tapissée.

Bistro

Design

| Projet: hermann + stumpp • ulm
all rights reserved | modèle exclusif



Finisings used at the arrangement:
chairs: wood 1.033, chrome

Finitions présentées dans cette page:
sièges: bois 1.033, chrome

The **Bistro** line consists of:
Ligne **Bistro** composée de:



Bistro

presented on this page
sièges présentés sur cette page



Bistro Hocker

page 138



Bistro Table

page 204



Bistro chrome



Bistro chrome plus



Stacking / Empilabilité
max 4 pieces / maximum 4 pièces

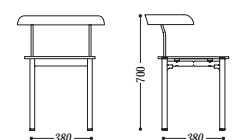

max / width: Ø 430

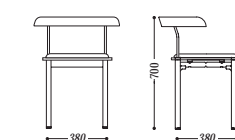

max / width: Ø 430

Metal elements
Finition tubes

alu

chrome

wood + upholstery + metal

/ bois + tapisserie + métal

CafeVI



Finishings used at the arrangement:
chairs: wood 3.093, chrome

Finitions présentées dans cette page:
sièges: bois 1.033, chrome

Modern Table
from Stylistica collection



The CafeVI line consists of:
Ligne CafeVI composée de:



CafeVI

presented on this page
sièges présentés sur cette page



CafeVI GTP

for more information see „OFFICE“ catalogue
complément d'information Nous consulter



Cafe Table

page 220

A chair with a chromium plated or powder coated metal frame, and a plywood seat and backrest shell. The seat plus version has a soft upholstered seat. The plus version has a soft upholstered seat and backrest.

Sièges avec structure en métal chromé ou époxy avec assise et dossier en hêtre multipli. En version "seat plus", assise rembourrée tapissée. En version "plus", assise et dossier rembourrés tapissés.



Finishings used at the arrangement:
chairs: wood 3.093, alu
Cafe Table alu
table top: werzalit® W055, Ø 60 cm
Finitions présentées dans cette page:
sièges: bois 3.093, époxy aluminium
Cafe Table: époxy aluminium
plateau: werzalit® W055, Ø 60 cm

Cafe Table
page 220



CafeVI chrome



CafeVI chrome seat plus



CafeVI 160 chrome plus



Stacking / Empilabilité
max 4 pieces / maximum 4 pièces

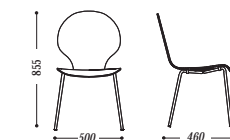

seat / assise: 470 seat / assise: 430

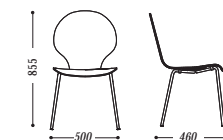

seat / assise: 470 seat / assise: 430



seat / assise: 470 seat / assise: 430

Metal elements
Finition tubes

alu

chrome

wood + upholstery + metal

/ bois + tapisserie + métal



A chair with a chromium plated or powder coated metal frame, with a plywood or soft upholstered seat, and a solid wooden backrest.

Sièges avec structure et dossier en métal chromé ou époxy avec assise rembourrée tapissée. En version "wood", assise en hêtre multipli.

Vento

Design | Projet: Wiesław Radoniewicz

 NEW

 UNIQUE DESIGN

Chairs | Sièges



Finishes used at the arrangement:
chairs: wood 1.010, alu
Dorino Table: ON 1.010, 80x80 cm
Finitions présentées dans cette page:
sièges: bois 1.010, alu
Dorino Table: ON 1.010, 80x80 cm

Dorino Table
page 200



Vento chrome



Vento wood alu

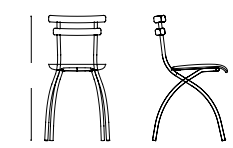

seat | width: 360 seat | width: 360

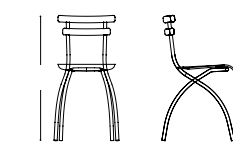

seat | width: 360 seat | width: 360

Metal elements
Finition tubes



For more information about finishings see our finishing cards.
Pour plus d'informations sur les finitions disponibles, se reporter à notre nuancier.

KONTORSENTRET

wood + upholstery + metal

/ bois + tapisserie + métal



A chair with a chromium plated or powder coated metal frame and a plywood seat and backrest or with a soft upholstered seat.
Sièges avec structure et dossier en métal chromé ou époxy avec assise rembourrée tapissée.
En version "wood", assise en hêtre multipli.

Fiamma

Design / Projet: Malgorzata Pe kala



Chairs | Sièges



◀ Finishing used at the arrangement:
chairs: wood 1.007, upholstery 18, chrome
Mella Bille: chrome
table top: ON 1.007, 80x80 cm
Finitions présentées dans cette page:
sièges: bois 1.007, tapisserie 18, chrome
Mella Bille: chrome
plateaux: ON 1.007, 80x80 cm

Mella Bille
page 206



The Fiamma line consists of:
Ligne Fiamma composée de:



Fiamma chrome



Fiamma Hocker wood alu
page 140



Fiamma 78 wood alu
page 140

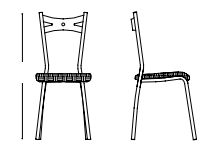

seat / assise: 380 seat / assise: 380

Metal elements
Finition tubes



wood + upholstery + metal

/ bois + tapisserie + métal



Finisings used at the arrangement:
chairs: wood 1.033, alu
Molino Tible alu
table top: werzalit® W070, 120x80 cm

Finitions présentées dans cette page:
sièges: bois 1.033, epoxy aluminium
Molino Tible epoxy aluminium
plateau: werzalit® W070, 120x80 cm

Molino Duo Tible
page 202



The Molino line consists of:
Ligne Molino composée de:



Molino

presented on this page
sièges présentés sur cette page



Molino Hocker

page 142



Molino Tible

page 202



Molino Duo Tible

page 202

A chair with a chromium plated or powder coated metal frame and backrest, and a plywood seat in wood version. Also available with a soft upholstered seat in plus version.

Sièges avec structure et dossier en métal chromé ou époxy
En version "wood", assise en hêtre multipli. En version "plus", assise rembourrée tapissée.

Molino

Design / Projet: Małgorzata Pe kala, Agata Danielak-Kujda



Finisings used at the arrangement:
chairs: wood 1.010, chrome
Tible Dona-3: chrome
table top: werzalit® W070, Ø 60 cm

Finitions présentées dans cette page:
sièges: bois 1.010, chrome
Tible Dona-3: chrome
plateau: werzalit® W070, Ø 60 cm

Dona-3
page 218



Molino alu plus



Molino alu wood



mat / assise: 400

mat / assise: 415

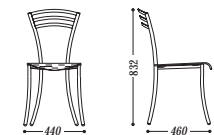

mat / assise: 385

mat / assise: 415

Metal elements
Finition tubes

alu

chrome

KONTORSENTRET

wood + upholstery + metal

| bois + tapisserie + métal



A chair with a chromium plated or powder coated metal frame and backrest, with a plywood or a soft upholstered seat.
 Sièges avec structure et dossier en métal chromé ou époxy.
 En version "wood", assise en hêtre multipli. En version "plus", assise rembourrée tapissée.

Dolce

Design | Projet: Malgorzata Pe kala



Chairs | Sièges



« Finisings used at the arrangement:
 chaises: wood 1.010, chrome
 Melba Table: chrome
 table top: ON 1.010, 80x80 cm
 Finitions présentées dans cette page:
 sièges: bois 1.010, chrome
 Melba Table: chrome
 plateau: ON 1.007, 80x80 cm

Melba Table
 page 206



The Dolce line consists of:
 Ligne Dolce composée de:



Dolce wood chrome



Dolce Hocker chrome
 page 144



Dolce 78 chrome
 page 144

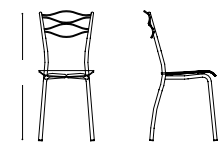

mat | matier: 300 mat | assise: 300

Metal elements
 Finition tubes



For more information about finishings see our finishing cards.
 Pour plus d'informations sur les finitions disponibles, se reporter à notre nuancier

wood + upholstery + metal

/ bois + tapisserie + métal



A chair with a chromium plated or powder coated metal frame and backrest, with a plywood or soft upholstered seat.

Sièges avec structure et dossier en métal chromé ou époxy. En version "wood", assise en hêtre multipli. En version "plus", assise rembourrée tapissée.

Baleno

Design

/Projet: Wiesław Radoniewicz



Chairs | Sièges



Finishing used at the arrangement:
 chairs upholstery SE-03, chrome
 table Rozana: chrome
 table top: transparent glass, Ø 90 cm
 Finitions présentées dans cette page:
 sièges tapisserie SE-03, chrome
 table Rozana: chrome
 plateau: verre transparent, Ø 90 cm

Rozana page 214



The Baleno line consists of:
Ligne Baleno composée de:



Baleno chrome



Baleno Hocker wood alu page 146



Baleno 78 wood alu page 146

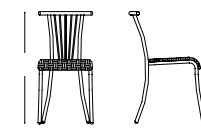

mat / anse: 378 mat / anse: 356

Metal elements
Finition tubes



For more information about finishings see our finishing cards
Pour plus d'informations sur les finitions disponibles, se reporter à notre nuancier

wood + upholstery + metal

/ bois + tapisserie + métal

Vega



Finisings used at the arrangement:
chairs: upholstery V27, chrome
table Dona-4: chrome
table top: werzalit® W011, Ø 60 cm

Finitions présentées dans cette page:
sièges: tapisserie V27, chrome
table Dona-4: chrome
plateau: werzalit® W011, Ø 60 cm

Dona-4
page 218



The Vega line consists of:
Ligne Vega composée de:



Vega

presented on this page
sièges présentés sur cette page



Vega Hocker

page 152



Vega chrome



Vega chrome wood

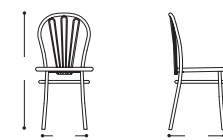

seat | anse: Ø 410



seat | anse: Ø 400

Metal elements
Finition tubes

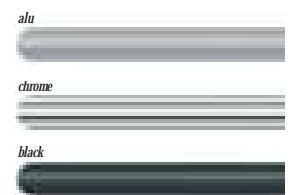

wood + upholstery + metal

/ bois + tapisserie + métal

Fosca



Finisings used at the arrangement:
chairs: upholstery V27, chrome
table Sonia 840: chrome
table top: transparent glass Ø 90 cm

Finitions présentées dans cette page:
sièges: tapisserie V27, chrome
table Sonia 840: chrome
plateau: verre transparent, Ø 90 cm

Sonia 840
page 215



A chair with a chromium plated or powder coated metal frame and backrest, and a soft upholstered seat. Also available with a plywood seat in wood version.

Sièges avec structure et dossier en métal chromé ou époxy avec assise rembourrée tapissée. En version "wood", assise en hêtre multipli.



Finisings used at the arrangement:
chairs: wood 1.008, alu
table Dona-3: alu
table top: verzinkt-W074, Ø 60 cm
Finitions présentées dans cette page:
sièges: bois 1.008, époxy aluminium
table Dona-3: époxy aluminium
plateau: verzinkt-W074, Ø 60 cm

Dona-3
page 218



Fosca chrome



Fosca wood chrome

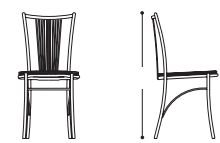

mat | anbr: Ø 410

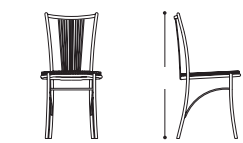

mat | anbr: Ø 400

Metal elements
Finition tubes

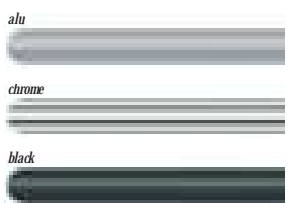

wood + upholstery + metal

/ bois + tapisserie + métal

Deco

A chair with a chromium plated or powder coated metal frame and backrest.
Available with a plywood seat in wood version or with a soft upholstered seat.
Sièges avec structure et dossier en métal chromé ou époxy. En version "wood",
assise en hêtre multipli. En version "plus", assise rembourrée tapissée.



Finisings used at the arrangement:
chairs: upholstery C-6, chrome
Tiramisu Table: chrome
table top: werzalit® W077, Ø 80 cm

Finitions présentées dans cette page:
sièges: tapisserie C-6, chrome
Tiramisu Table: chrome
plateau: werzalit® W077, Ø 80 cm

Tiramisu Table
page 208

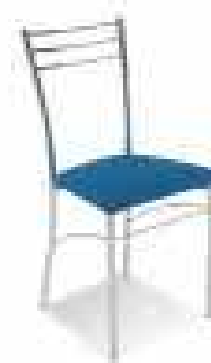

Deco chrome plus

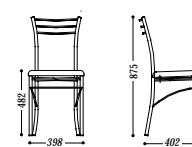

seat | anbre: 410 seat | anbre: 350

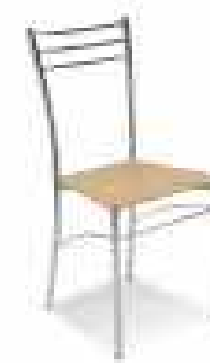

Deco wood chrome

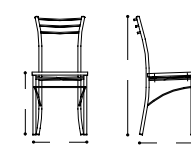

seat | anbre: 410 seat | anbre: 350

Metal elements
Finition tubes

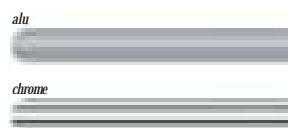

wood + upholstery + metal

/ bois + tapisserie + métal

Anca

A chair with a chromium plated or powder coated metal frame and a plywood seat and backrest in wood version and with a soft upholstered seat in plus version.

Sièges avec structure et dossier en métal chromé ou époxy avec assise rembourrée tapissée. En version "wood", assise en hêtre multipli.

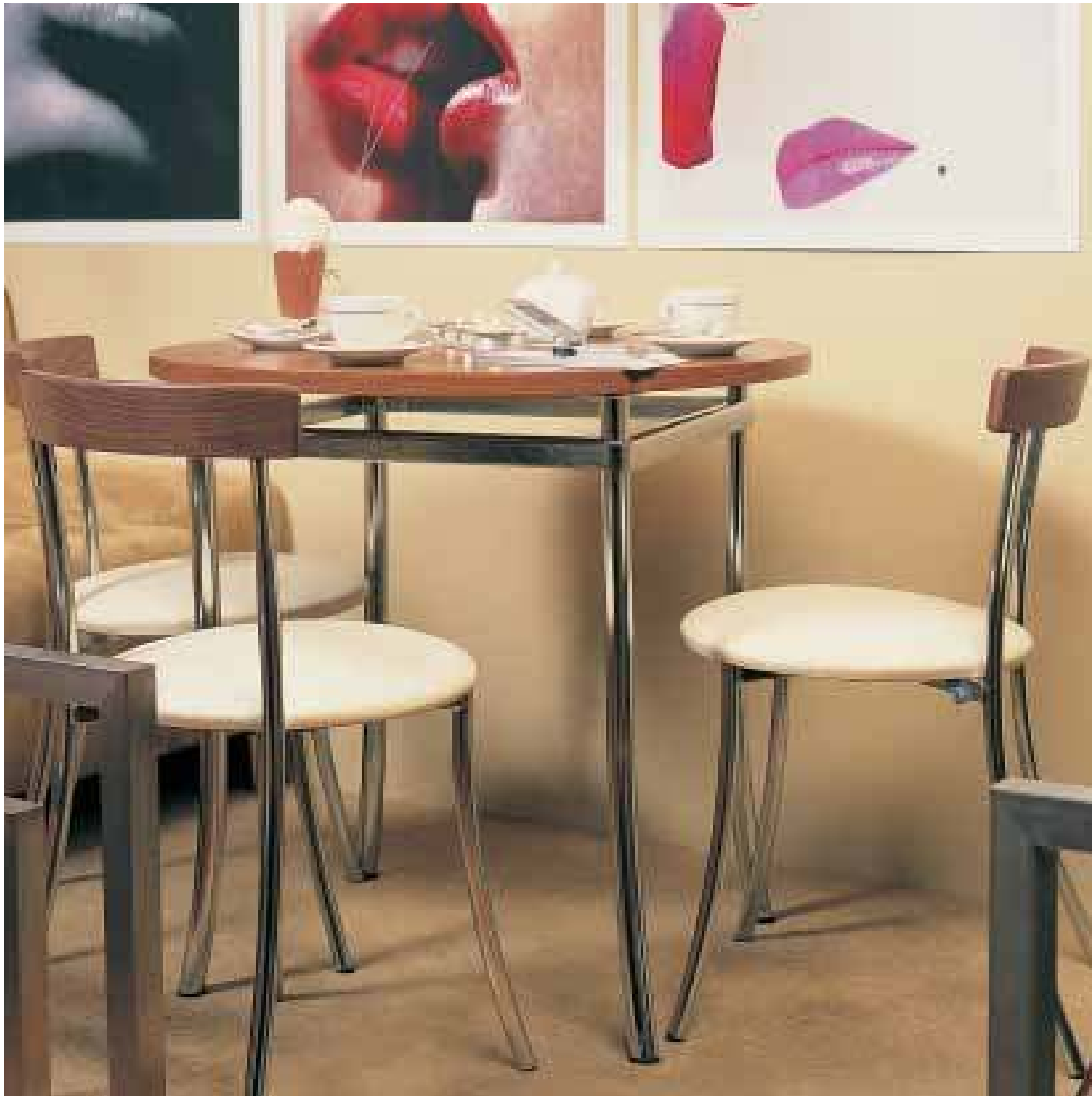

Finishings used at the arrangement:
chairs: wood 1.031, upholstery V18, chrome
Molino Table: chrome
table top: MA-NN, Ø 80 cm

Finitions présentées dans cette page:
sièges: bois 1.031, tapisserie V18, chrome
Molino Table: chrome
plateau: MA-NN, Ø 80 cm

Molino Table
page 202



Anca chrome plus



mat | color: Ø 410

Anca wood chrome



mat | color: Ø 410

Metal elements
Finition tubes

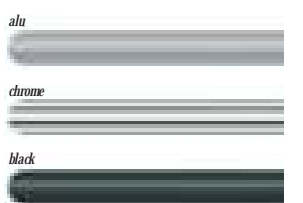

wood + upholstery + metal

| bois + tapisserie + métal

A chair with a chromium plated or powder coated metal frame and backrest, and a soft upholstered seat. Also available with a plywood seat in wood version.

Siège avec structure et dossier en métal chromé ou époxy avec assise rembourrée tapissée. En version "wood", assise en hêtre multipli.

Venus



Finishing used at the arrangement:
chairs: wood 1.033, alu
table Dona-3: alu
table top: werzalit-W074, Ø 60 cm

Finitions présentées dans cette page:
sièges: bois 1.033, époxy aluminium
table Dona-3: époxy aluminium
plateau: werzalit-W074, Ø 60 cm

Dona-3
page 218



The Venus line consists of:
Ligne Venus composée de:



Venus

presented on this page
sièges présentés sur cette page



Venus Hocker

page 150



Venus alu

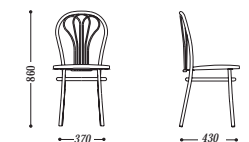

mat / matier: Ø 410



Venus black

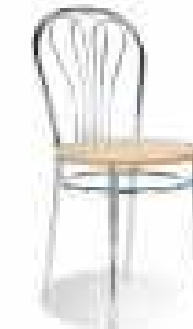

Venus wood chrome

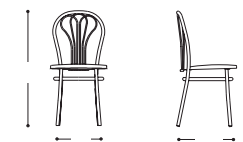

mat / matier: Ø 400

Metal elements
Finition tubes



wood + upholstery + metal

/ bois + tapisserie + métal

Tulipan

A chair with a chromium plated or powder coated metal frame and backrest, and a soft upholstered seat. Also available with a plywood seat in wood version.

Siège avec structure et dossier en métal chromé ou époxy, avec assise rembourrée tapissée. En version "wood", assise en hêtre multipli.



Finishings used at the arrangement:
chairs: wood 1.010, chrome
table Lena: chrome
table top: werzalit® W055, Ø 60 cm

Finitions présentées dans cette page:
sièges: bois 1.010, chrome
table Lena: chrome
plateau: werzalit® W055, Ø 60 cm

Lena
page 224



The Tulipan line consists of:
Ligne Tulipan composée de:



Tulipan

presented on this page
sièges présentés sur cette page



Tulipan Hocker

page 154



Tulipan chrome

Tulipan alu

Tulipan black

Tulipan wood chrome

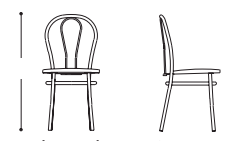

seat / assise: Ø 410

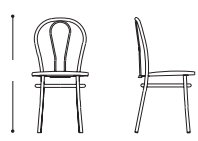

seat / assise: Ø 400

Metal elements
Finition tubes

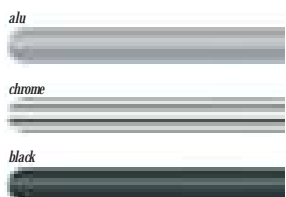



Finishings used at the arrangement:
chairs wood 1.033, chrome

Finitions présentées dans cette page:
sièges bois 1.033, chrome

Modern Table
from Stylistica collection



The Samba Wood line consists of:
Ligne Samba Wood composée de:



Samba Wood

presented on this page
sièges présentés sur cette page



Samba

page 84



Samba GTP

for more information see „OFFICE“ catalogue
complément d'information Nous consulter

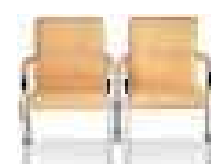

Samba link

for more information see our „OFFICE“ catalogue
complément d'information sur les pièces
de liaison des sièges catalogue „OFFICE“

A chair with a chromium plated metal frame with a plywood seat and backrest shell and wooden armrest pads. The Samba-link allows linking Samba chairs in rows.

Siège avec structure en métal époxy ou chromé, assise et dossier en hêtre multipli et accotoirs bois. En option, pièce de liaison Samba-link permettant d'aligner les sièges.

Samba Wood



Samba Wood chrome

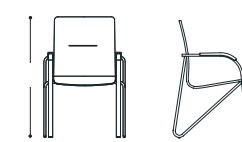

seat / dossier: 445



Stacking/ Empilabilité

max 4 pieces/ maximum 4 pieces



seat / dossier: 400

Metal elements
Finition tubes

chrome





A chair with a chromium plated or powder coated metal frame with a plywood seat and backrest shell and wooden armrests. The Salsa-link which allows linking Salsa chairs in rows.

Siège avec structure en métal époxy ou chromé, assise et dossier en hêtre multipli et accotoirs bois. En option, pièce de liaison Salsa-link permettant d'aligner les sièges.



Finishing used at the arrangement:
chairs: wood 1.008, chrome
Bistro table: chrome
table top: werzalit® W055, Ø 60 cm

Finitions présentées dans cette page:
sièges: bois 1.008, chrome
Bistro table: chrome
plateau: werzalit® W055, Ø 60 cm

Bistro table
page 204



The Salsa Wood line consists of:
Ligne Salsa Wood composée de:



Salsa Wood

presented on this page
sièges présentés sur cette page



Salsa

page 24

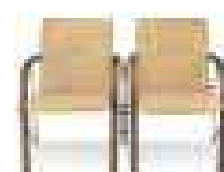

Salsa link

for more information see our OFFICE catalogue
complément d'information sur les pièces de liaison
des sièges catalogue OFFICE



Salsa Wood chrome

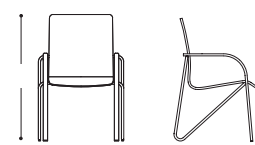

seat | assise: 445 seat | assise: 420



Stacking/ Empilabilité
max 4 pieces/ maximum 4 pièces

Metal elements
Finition tubes

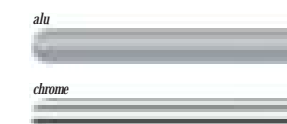



Finishings used at the arrangement:
chairs: wood 1.033, alu

Finitions présentées dans cette page:
sièges: bois 1.033, epoxy aluminium

The Dolly line consists of:
Ligne Dolly composée de:



Dolly

presented on this page
sièges présentées sur cette page



Dolly Hocker

page 158



Dolly Stool

page 184



Dolly Table

page 212

A chair with a chromium plated or powder coated metal frame,
with a plywood seat and backrest.

Siège avec structure en métal chromé ou époxy
avec assise et dossier en hêtre multipl.

Dolly

Design | Projet: Mikołaj Wierszylowski



Finishings used at the arrangement:
chairs: wood 1.010, chrome
Dolly Table 380: chrome
table top: wozzolit® W011, Ø 90 cm
Finitions présentées dans cette page:
sièges: bois 1.010, chrome
Dolly Table 380: chrome
plateau: wozzolit® W011, Ø 90 cm

Dolly Table
page 212



Dolly alu



Stacking / Empilabilité
max 4 pieces / maximum 4 pièces

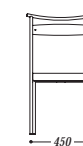

seat | assise: 404

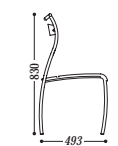

seat | assise: 470

Metal elements
Finition tubes

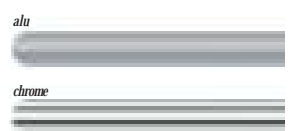

wood + metal / bois + métal



Finisings used at the arrangement:
chairs: wood 1.010, chrome
Melba Table: chrome
table top: werzalit-W011, Ø 80 cm

Finitions présentées dans cette page:
sièges: bois 1.010, chrome
Melba Table: chrome
plateau: werzalit-W011, Ø 80 cm

Melba Table
page 206



A chair with a chromium plated or powder coated metal frame,
with a plywood seat and backrest.

Sièges avec structure en métal chromé ou époxy avec assise et dossier en hêtre multipli.



Medea

Design / Projet: I.D. Associates



Medea chrome

Stacking / Empilabilité
max 3 pieces / maximum 3 pièces

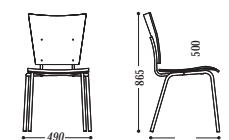

mat / table: 440

mat / assise: 420

Metal elements
Finition tubes





Finishings used at the arrangement:
 chairs: wood 2.003, chrome
 table Lena: chrome
 table top: werzalit-W055, Ø 60 cm

Finitions présentées dans cette page:
 sièges: bois 2.003, chrome
 table Lena: chrome
 plateau: werzalit-W055, Ø 60 cm

Lena
 page 224



A chair with chromium plated or powder coated metal frame, and a stained plywood seat and backrest.
 Siège avec structure en métal chromé ou époxy avec assise et dossier en hêtre multipli.



Finishings used at the arrangement:
 chairs: wood 1.033, alu
 Dolly/Bble 380: alu
 table top: werzalit-W052, Ø 90 cm
Finitions présentées dans cette page:
 sièges: bois 1.033, epoxy aluminium
 Dolly/Bble 380: epoxy aluminium
 plateau: werzalit-W052, Ø 90 cm

Dolly Bble 380
 page 212



Ristretto chrome



Stacking/ Empilabilité
 max 6 pieces/ maximum 6 pièces

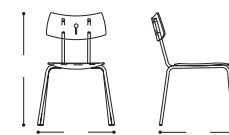

seat | assise: 396 seat | assise: 420

Ristretto

Design | Projet: Holger Henn



Metal elements
 Finition tubes





A chair with a chromium plated or powder coated metal frame, and a plywood seat and backrest shell.
Siège avec structure en métal époxy ou chromé, avec manœuvre assise / dossier en hêtre multipli.



Finisings used at the arrangement:
chairs: wood 1.033, chrome
table Sonia 840: chrome
table top: transparent glass Ø 90 cm

Finitions présentées dans cette page:
sièges: bois 1.033, chrome
table Sonia 840: chrome
plateau: verre transparent, Ø 90 cm

Sonia 840
page 215



The Cafe II line consists of:
Ligne Cafe II composée de:



Cafe II

presented on this page
sièges présentés sur cette page



Cafe II table

page 220



Cafe II alu



Cafe II chrome



Stacking / Empilabilité
max 4 pieces / maximum 4 pièces



mat | assise: 430



mat | assise: 430

Metal elements
Finition tubes



wood + metal / bois + métal



Finishes used at the arrangement:
 chairs: wood 3.096, chrome
 table Dona-3: chrome
 table top: werzalit-W055, Ø 60 cm

Finitions présentées dans cette page:
 sièges: bois 3.096, chrome
 table Dona-3: chrome
 plateau: werzalit-W055, Ø 60 cm

Dona-3
 page 218



The Cafe III line consists of:
 Ligne Cafe III composée de:



Cafe III

presented on this page
 sièges présentés sur cette page



Cafe Table

page 220

A chair with a chromium plated or powder coated metal frame,
 and a plywood seat and backrest shell.

Siège avec structure en métal époxy ou chromé,
 avec monoque assise / dossier en hêtre multiplié.



Cafe III chrome



Stacking / Empilabilité
 max 4 pièces / maximum 4 pièces

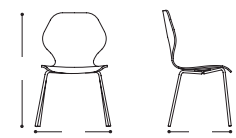

seat / assise: 475



seat / assise: 430

Metal elements
 Finition tubes



Cafe III



A chair with a chromium plated or powder coated metal frame, and a plywood seat and backrest shell.

Siège avec structure en métal chromé ou époxy avec assise et dossier en hêtre multipli.



Finishings used at the arrangement:
chairs: wood 1.008, chrome

Finitions présentées dans cette page:
sièges: bois 1.008, chrome



Finishings used at the arrangement:
chairs: wood 1.007, chrome

Finitions présentées dans cette page:
sièges: bois 1.007, chrome

Modern Table
from Stylistica collection



The Cafe IV line consists of:
Ligne Cafe IV composée de:



Cafe IV

presented on this page
sièges présentés sur cette page



Cafe Table

page 220



Cafe IV chrome



Stacking/ Empilabilité
max 4 pieces/ maximum 4 pieces

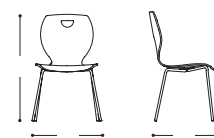

seat / assise: 470



seat / assise: 430

Metal elements
Finition tubes

alu

chrome



A chair with a chromium plated or powder coated metal frame, and a plywood seat and backrest shell.

Siège avec structure en métal époxy ou chromé, avec mono-coque assise / dossier en hêtre multipli.



Finishes used at the arrangement:
chairs: wood 3.094 (red), 3.097 (black), chrome
table Dona-3: chrome
table top: werzalit® W055, Ø 60 cm

Finitions présentées dans cette page:
sièges: bois 3.094 (rouge), 3.097 (noir), chrome
table Dona-3: chrome
plateau: werzalit® W055, Ø 60 cm

Dona-3
page 218



The Cafe IV line consists of:
Ligne Cafe IV composée de:



CafeV

presented on this page
sièges présentés sur cette page



Cafe Table

page 220



CafeV chrome

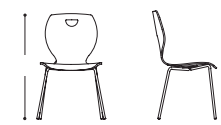

seat / assise: 470



Stacking | Empilabilité
max 4 pieces | maximum 4 pièces

seat / assise: 430

Metal elements
Finition tubes





Finishings used at the arrangement:
chairs: wood 1.010, alu

Finitions présentées dans cette page:
sièges: bois 1.010, alu

Modern Table
from Stylistica collection



A chair with a chromium plated or powder coated metal frame,
and a plywood seat and backrest shell.

Siège avec structure en métal époxy ou chromé,
avec monoque assise / dossier en hêtre multipli.



Finishings used at the arrangement:
chairs: wood 1.010, alu
Cafe Table: alu
table top: werzalit® W077, Ø 60 cm

Cafe Table
page 220



CafeVII chrome



Stacking/ Empilabilité
max 4 pieces/ maximum 4 pièces

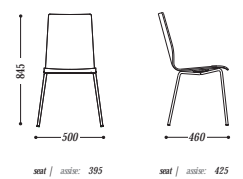

seat | assise: 385

seat | assise: 425

Metal elements
Finition tubes

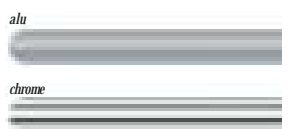

CafeVII

presented on this page
siège présentée sur cette page



Cafe Table

page 220



A chair with a chromium plated metal frame, with a soft upholstered seat and backrest, and solid wooden armrest pads. The Samba-link allows linking Samba chairs in rows.
Siège avec structure en métal chromé, assise et dossier rembourrés tapissés.
En option, pièce de liaison Samba-link permettant d'aligner les sièges.



Finishings used at the arrangement:
chairs: upholstery V47, wood 1.008, chrome
Finitions présentées dans cette page:
sièges: tapiserie V47, bois 1.008, chrome



Finishings used at the arrangement:
chairs: upholstery V18, wood 1.008, chrome
Bistro Table: chrome
table top: type MA-NN, Ø 80 cm

Finitions présentées dans cette page:
sièges: tapiserie V18, bois 1.008, chrome
Bistro Table: chrome
plateau: type MA-NN, Ø 80 cm

Bistro Table
page 204



The Samba line consists of:
Ligne Samba composée de:



Samba

presented on this page
sièges présentés sur cette page



Samba Wood

page 64



Samba GTP

for more information see „OFFICE“ catalogue
complément d'information Nous consulter



Samba link

for more information see our „OFFICE“ catalogue
complément d'information sur les pièces
de liaison des sièges: catalogue „OFFICE“



Samba

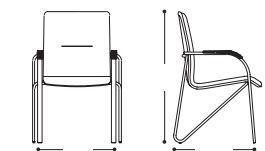

width | largeur: 460

width | largeur: 430



Stacking | Empilabilité
max 4 pieces | maximum 4 pièces

Metal elements
Finition tubes

chrome





Finishings used at the arrangement:
 chairs: upholstery NV-08, wood 1.007, chrome
 table: Wiktor: chrome
 table top: MA-NB, Ø 60 cm

Finitions présentées dans cette page:
 sièges: tapisserie NV-08, bois 1.007, chrome
 table: Wiktor: chrome
 plateau: MA-NB, Ø 60 cm

Wiktor
 page 221



A chair with chromium plated metal frame, and a soft upholstered seat and backrest.
 Wooden pads on armrests in arm version.

Siège avec structure en métal époxy assise et dossier rembourrés tapissés.
 En version "arm" - accotoirs bois.

Ibis

Design | /Projet: herrmann + stumpf • ulm



Ibis



Ibis arm



Stacking/ Empilabilité
 max 4 pieces/ maximum 4 pièces



Stacking/ Empilabilité
 max 4 pieces/ maximum 4 pièces

Metal elements
 Finition tubes

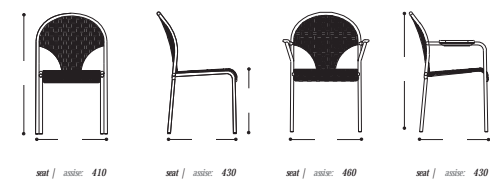

width | depth: 410 width | depth: 430 width | depth: 460 width | depth: 430

upholstery + metal

/ tapiserie + métal

Kelly

A chair with a chromium plated or powder coated metal frame,
and a soft upholstered seat and backrest, and wooden armrest pads.
Siège avec structure en métal époxy assise et dossier rembourrés tapissés et accotoirs en bois.

Chairs | Sièges



Finishes used at the arrangement:
chairs: upholstery V-04, wood 1.008, chrome
table Lena: chrome
table top: werzalit-W055, Ø 60 cm

Finitions présentées dans cette page:
sièges: tapiserie V-04, bois 1.008, chrome
table Lena: chrome
plateau: werzalit-W055, Ø 60 cm

Lena
page 224



Kelly chrome

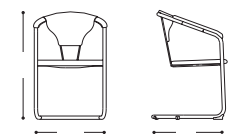

wd | sd: 430 wd | sd: 430



Stacking | Empilabilité
max 2 pièces | maximum 2 pièces

Metal elements
Finition tubes





A chair with a chromium plated or powder coated metal frame and backrest and a soft upholstered seat and element in the backrest.
Siège avec structure en métal époxy assise et dossier rembourrés tapisés.

Tiziano

Design

| Projet: MikalajWierszylowski



Chairs | Sièges



◀ *Finisings used at the arrangement:*
chairs: upholstery V-46, chrome
table Karina - chrome
table top: ON 1.010, Ø 80 cm
Finitions présentées dans cette page:
sièges: tapiserie V-46, chrome
table Karina: chrome
plateau: ON 1.010, Ø 80 cm

Karina
page 217



The Tiziano line consists of:
Ligne Tiziano composée de:



Tiziano chrome



Tiziano Hocker chrome
page 166



Tiziano 78 chrome
page 166

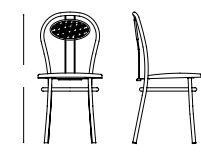

seat | assise: Ø 410

Metal elements
Finition tubes



For more information about finishings see our finishing cards.
Pour plus d'informations sur les finitions disponibles, se reporter à notre nuancier.





A chair with a chromium plated or powder coated metal frame and backrest, and a soft upholstered seat.

Siège avec structure et dossier en métal chromé ou époxy avec assise rembourrée tapissée.

Caldo

Design / Projet: Mikołaj Wierszylowski



Chairs | Stages



« Finishes used at the arrangement:
chairs: upholstery V19, chrome
Tiramisu Duo Table: chrome
table top: ON 1.033, 120x80 cm
Finitions présentées dans cette page:
sièges: tapiserie V19, chrome
Tiramisu Duo Table: chrome
plateau: ON 1.033, 120x80 cm

Tiramisu Duo Table
page 208

The Caldo line consists of:
Ligne Caldo composée de:



Caldo chrome



Caldo Hocker chrome
page 162



Caldo 78 chrome
page 162



Stacking / Empilabilité
max 6 pieces / maximum 4 pièces

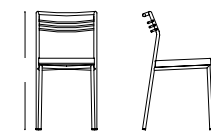

seat | assise: 378 seat | dossier: 365

Metal elements
Finition tubes



For more information about finishes see our finishing cards
Pour plus d'informations sur les finitions disponibles, se reporter à notre nuancier



Finishings used at the arrangement:
chairs: upholstery V18, alu
table Dona-3, alu
table top: werzalit-W077, Ø 60 cm

Finitions présentées dans cette page:
sièges: tapisserie V18, epoxy aluminium
table Dona-3: epoxy aluminium
plateau: werzalit-W077, Ø 60 cm

Dona-3
page 218



A chair with a chromium plated or powder coated metal frame,
and a soft upholstered seat and backrest.
Siège avec structure en métal epoxy assise et dossier rembourrés tapissés.



Visa chrome



Visa alu



Stacking / Empilabilité
max 2 pièces / maximum 2 pièces

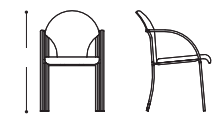

mat | intèr: 450



mat | intèr: 450

Metal elements
Finition tubes

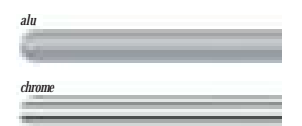



A chair with a powder coated metal frame and backrest, and a soft upholstered seat and element in the backrest.
Siège avec structure en métal époxy avec assise et dossier rembourrés tapissés.



Finishings used at the arrangement:
chairs: upholstery V23, alu
Cafe Table: alu
table top: werzalit® W074, Ø 60 cm

Finitions présentées dans cette page:
sièges: tapisserie V23, époxy aluminium
Cafe Table: époxy aluminium
plateau: werzalit® W074, Ø 60 cm

Cafe Table
page 220



Zeus alu



Zeus black

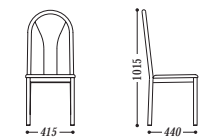

seat | assise: 470 seat | assise: 410

Metal elements
Finition tubes





A chair with chromium plated or powder coated metal frame and backrest, and with a soft upholstered seat. Backrest with a wooden element.
Siège avec structure et dossier en métal chromé ou époxy avec assise rembourrée tapisée.



Finishings used at the arrangement:
chairs: upholstery V-16, wood 1.007, chrome
Café Table: chrome
table top: werzalit W038, Ø 60 cm

Finitions présentées dans cette page:
sièges: tapiserie V-16, bois 1.007, chrome
Café Table: chrome
plateau: werzalit W038, Ø 60 cm

Café Table
page 220



The Grigio line consists of:
Ligne Grigio composée de:



Grigio

Grigio Hocker

presented on this page
sièges présentés sur cette page

page 164



Grigio chrome



seat | assise: Ø 410

Metal elements
Finition tubes

alu

chrome





A chair with a chromium plated or powder coated metal frame and backrest, and a soft upholstered seat.
 Siège avec structure et dossier en métal chromé ou époxy avec assise rembourrée tapissée.



Finisings used at the arrangement:
 chairs: upholstery V25, chrome
 table: Lena: chrome
 table top: werzalit - W055, Ø 60 cm

Finitions présentées dans cette page:
 sièges: tapisserie V25, chrome
 table: Lena: chrome
 plateau: werzalit - W055, Ø 60 cm

Lena
 page 224



The Arancia line consists of:
 Ligne Arancia composée de:



Arancia

presented on this page
 sièges présentées sur cette page



Arancia Hocker

page 168



Arancia chrome

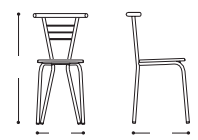

seat | assise: Ø 410

Metal elements
 Finition tubes

alu

chrome

upholstery + metal / tapisserie + métal



Finisings used at the arrangement:
chairs: upholstery V-18, chrome
Tiramisu Bible: chrome
table top: MA-NN, Ø 80 cm

Finitions présentées dans cette page:
sièges: tapisserie V-18, chrome
Tiramisu Bible: chrome
plateau: MA-NN, Ø 80 cm

Tiramisu Bible
page 208



The Azzurro line consists of:
Ligne Azzurro composée de:

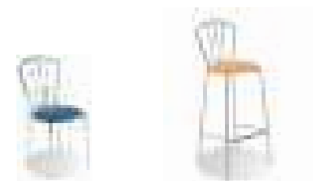

Azzurro

Azzurro Hocker

presented on this page
sièges présentés sur cette page

page 172

A chair with a chromium plated or powder coated metal frame and backrest, and a soft upholstered seat.

Siège avec structure et dossier en métal chromé ou époxy avec assise rembourrée tapissée.



Azzurro



Azzurro alu

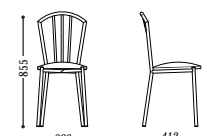

mat / article: Ø 370

Metal elements
Finition tubes

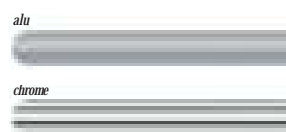

A chair with a chromium plated or powder coated metal frame and backrest, and a soft upholstered seat.
Siège avec structure en métal chromé, assise et dossier rembourrés tapissés.



Finishes used at the arrangement:
chairs: upholstery V29, chrome
table Wiktor: chrome
table top: MA-MS, Ø 60 cm

Finitions présentées dans cette page:
sièges: tapisserie V29, chrome
table Wiktor: chrome
plateau: MA-MS, Ø 60 cm

Wiktor
page 221



Vena chrome



Stacking | Empilabilité
max 4 pieces | maximum 4 pièces

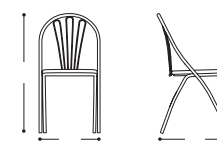

seat | assise: Ø 410

Metal elements
Finition tubes





A chair with a chromium plated or powder coated metal frame and backrest, and a soft upholstered seat.

Siège avec structure et dossier en métal chromé ou époxy avec assise rembourrée tapissée.



Finisings used at the arrangement:
chairs: upholstery V04, chrome
Tacy Table: chrome
table top: werzalit® W014, Ø 80 cm

Finitions présentées dans cette page:
sièges : tapisserie V04, chrome
Tacy Table: chrome
plateau: werzalit® W014, Ø 80 cm

Tacy Table
page 210



The Rosso line consists of:
Ligne Rosso composée de:

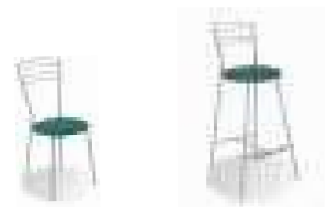

Rosso

Rosso Hocker

presented on this page
sièges présentés sur cette page

page 174



Rosso alu

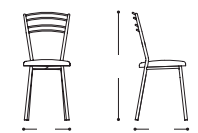

mat / matier: Ø 370

Metal elements
Finition tubes





Giallo chrome

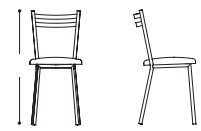

mat | anse: Ø 370

Finishings used at the arrangement:
chairs: upholstery V27, chrome
Café Table: chrome
table top: werzalit® W074, Ø 60 cm

Finitions présentées dans cette page:
sièges: tapiserie V27, chrome
Café Table: chrome
plateau: werzalit® W074, Ø 60 cm

Café Table
page 220



The Giallo line consists of:
Ligne Giallo composée de:



Giallo

presented on this page
sièges présentés sur cette page



Giallo Hocker

page 176

Metal elements
Finition tubes





Finishings used at the arrangement:
chairs: upholstery V49, chrome
table Kaja: chrome
table top: **WERZALIT** MA-NE, 80x80 cm

Finitions présentées dans cette page:
sièges V49, chrome
table Kaja: chrome
plateau: **WERZALIT** MA-NE, 80x80 cm

Kaja
page 216



The Neron line consists of:
Ligne Neron composée de:



Neron

Neron Hocker

presented on this page
sièges présentés sur cette page

page 170

A chair with a chromium plated or powder coated metal frame and backrest, and with a soft upholstered seat.

Siège avec structure et dossier en métal chromé ou époxy avec assise rembourrée tapissée.



Neron chrome



Neron alu

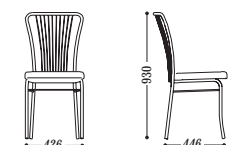

seat | assise: 430

seat | assise: 430

Metal elements
Finition tubes

alu

chrome

upholstery + metal

/ tapiserie + métal

Argento

★ NEW

Chairs | Sièges



A chair with a chromium plated or powder coated metal frame and backrest and a soft upholstered seat.
 Siège avec structure et dossier en métal chromé ou époxy avec assise rembourrée tapissée.



Finishing used at the arrangement:
 chairs upholstery V15, chrome
 table Karina: chrome
 table top: werzalit® W064, Ø 80 cm
 Finitions prévues dans cette page:
 sièges tapiserie V15, chrome
 table Karina: chrome
 plateau: werzalit® W064, Ø 80 cm

Karina
page 217



Argento chrome

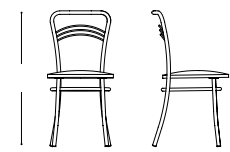

mat | inox | Ø 40

Metal elements
Finition tubes

alu

chrome



A chair with a chromium plated or powder coated metal frame and backrest and a soft upholstered seat.

Siège avec structure et dossier en métal chromé ou époxy avec assise rembourrée tapissée.

Marino

★ NEW

Chairs | Sièges



4 Finishing used at the arrangement:
chairs: upholstery V17, chrome
Finitions présentées dans cette page:
sièges: tapisserie V17, chrome



Marino alu

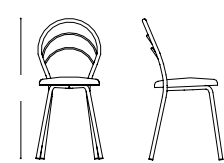

mat | antracite | Ø 370

Metal elements
Finition tubes



upholstery + metal

/ tapisserie + métal

A chair with a chromium plated or powder coated metal frame and backrest and a soft upholstered seat.

Siège avec structure et dossier en métal chromé ou époxy avec assise rembourrée tapissée.

Castano

★ NEW

Chairs | Stages



◀ *Finisings used at the arrangement:*
chairs: upholstery V17, chrome
Melba Table: chrome
table top: MA-NN, Ø 80 cm
Finitions présentées dans cette page:
sièges: tapisserie V17, chrome
Melba Table: chrome
plateaux: MA-NN, Ø 80 cm

Melba Table
page 206



Castano chrome

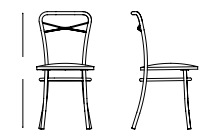

seat | width: Ø 410

Metal elements
Finition tubes





A chair with a chromium plated or powder coated metal frame and backrest and a soft upholstered seat.

Siège avec structure et dossier en métal chromé ou époxy avec assise rembourrée tapissée.

Amaro

NEW

Chairs | Sieges



◀ Finishing used at the arrangement:
 chair upholstery V26, chrome
 Claudia Bibi chrome
 table top: MA-CY0 80 cm
 Finitions présentées dans cette page:
 sièges tapisseries V26, chrome
 Claudia Bibi chrome
 plateau: MA-CY0 80 cm

Claudia Bibi
 page 222



Amaro chrome

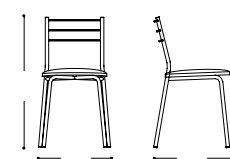

width | width: 380 width | width: 380



Stacking / Empilabilité
 max 4 pieces / maximum 4 pièces

Metal elements
 Finition tubes

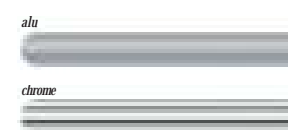

upholstery + metal / tapisserie + métal



Finishings used at the arrangement:
chairs: upholstery V-13, alu
Rico table: alu

Finitions présentées dans cette page:
sièges: tapisserie V-13, epoxy aluminium
Rico table: epoxy aluminium

Rico table
page 225



A chair with a powder coated metal frame, a soft upholstered seat and backrest and a handle in the upper part of a backrest to carry the chair.
Siège avec structure et dossier en métal epoxy avec assise rembourrée tapissée. Poignée intégrée à la forme du dossier pour faciliter le transport.



Alerto black



Stacking/ Empilabilité
max 6 pieces/ maximum 6 pièces

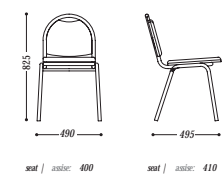

mat | acier: 400 mat | acier: 410

Alerto

Chairs | Sièges

Metal elements
Finition tubes

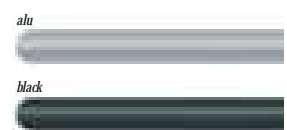

upholstery + metal

/ tapiserie + métal

Ascona

Chairs | Sièges



Ascona

Stacking / Empilabilité
max 8 pieces / maximum 8 pièces

Metal elements
Finition tubes



Finishing used at the arrangement:
chairs upholstery - artificial material
in black colour chrome
Tiramisu table chrome
table top: werzalit® W055, Ø 90 cm

Finitions présentées dans cette page:
sièges tapiserie - similicuir de couleur noir chrome
Tiramisu table chrome
plateau: werzalit® W055, Ø 90 cm

Tiramisu Table
page 208

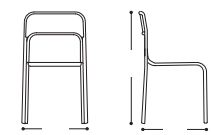

seat | assise: 360

seat | assise: 380

plastic + upholstery + metal

/ plastique + tapisserie + métal

Beta

Chairs | Sièges



Finishings used at the arrangement:
chairs: K-35, chrome
table Karina: black
table top: werzalit™ W055, Ø 90 cm

Finitions présentées dans cette page:
sièges: K-35, chrome
table Karina: black (noire)
plateau: werzalit™ W055, Ø 90 cm

Karina
page 217



The Beta line consists of:
Ligne Beta composée de:

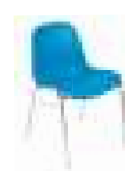

Beta



Beta GTS



Beta click



Beta-3

presented on this page
sièges présentés sur cette page

for more information see our
„OFFICE“ catalogue
complément d'information sur les pièces
de liaison des sièges : catalogue „OFFICE“

for more information see our price list
complément d'information Nous consulter

for more information see our „OFFICE“ catalogue
complément d'information sur les pièces
de liaison des sièges : catalogue „OFFICE“



Beta

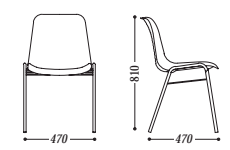

seat | assise: 430

seat | assise: 400



Beta plus

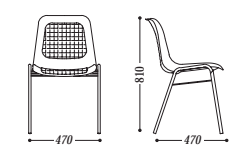

seat | assise: 430

seat | assise: 400

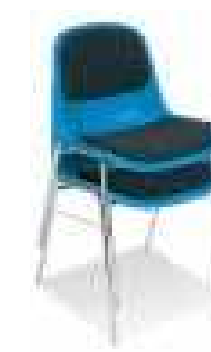

Stacking | Empilabilité
max 6 pieces | maximum 6 pièces

Metal elements
Finition tubes

chrome



plastic + upholstery + metal

/ plastique + tapisserie + métal



Finishings used at the arrangement:
chairs:TK-31, K-31, alu
Rico Table-3: alu

Finitions présentées dans cette page:
sièges:TK-31, K-31, époxy aluminium
Rico Table-3: époxy aluminium

Rico Table-3
page 225



A folding chair with powder coated metal frame, and a plastic seat and backrest.
A soft upholstered seat and backrest in plus version.
Siège pliante avec structure en métal époxy, assise et dossier en polypropylène injecté.
En version "plus" - assise et dossier rembourrés tapissés.



Polyfold alu

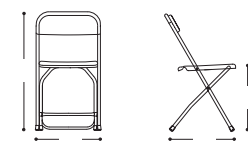

seat / assise: 400 seat / assise: 400



Polyfold black plus

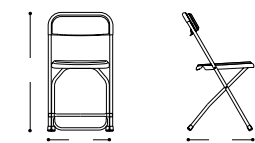

seat / assise: 400 seat / assise: 400

Metal elements
Finition tubes

black



alu



Polyfold

Chairs | Sièges

Amigo

Design

| Projet: hermann + stump • ulm
all rights reserved | modèle exclusif



Finishings used at the arrangement:
chairs: K-30 (red), K-33 (orange), chrome
table: Lena: chrome
table top: werzalit-W055, Ø 60 cm

Finitions présentées dans cette page:
sièges: K-30 (rouge), K-33 (orange), chrome
table: Lena: chrome
plateau: werzalit-W055, Ø 60 cm

Lena
page 224



The Amigo line consists of:
Ligne Amigo composée de:



Amigo

presented on this page
sièges présentés sur cette page



Amigo GTP

for more information see our
.OFFICE catalogue
complément d'information sur les pièces
de liaison des sièges: catalogue .OFFICE

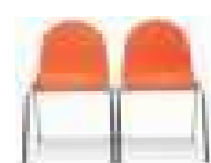

Amigo click

for more information see our price list
complément d'information Nous consulter



Amigo-3

for more information see our .OFFICE catalogue
complément d'information sur les pièces
de liaison des sièges: catalogue .OFFICE

A chair with a chromium plated or powder coated metal frame and a plastic seat and backrest shell, non-slippery seat surface. The arm version has armrests with plastic pads. The click frame version allows linking chairs in rows.

Siège avec structure en métal chromé, avec assise et dossier plastique. Surface du dossier avec relief anti-glisse. En version "arm", accotoirs plastique. En version "click", structure intégrant un système de connexion pour aligner les sièges.



Finishings used at the arrangement:
chairs: K-72, chrome
table: Wiktor, chrome
table top: werzalit-W077, Ø 60 cm

Finitions présentées dans cette page:
sièges: K-72, chrome
table: Wiktor, chrome
plateau: werzalit-W077, Ø 60 cm

Wiktor
page 221



Amigo chrome

Stacking/ Empilabilité
max 8 pieces/ maximum 8 pièces

Amigo arm chrome

Stacking/ Empilabilité
max 8 pieces/ maximum 8 pièces

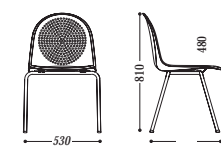

seat | assise: 460 seat | assise: 480

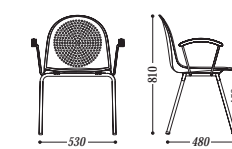

seat | assise: 460 seat | assise: 480

Metal elements
Finition tubes



plastic + metal / plastique + métal



Finisings used at the arrangement:
chairs: K-30, chrome
table Kaja: black
table top: werzalit® W055, Ø 80 cm

Finitions présentées dans cette page:
sièges K-30, chrome
table Kaja: black (noir)
plateau: werzalit® W055, Ø 80 cm

Kaja
page 216



A chair with a chromium plated metal frame, and a plastic seat and backrest.
Siège avec structure en métal chromé, avec assise et dossier plastique.



Cortina



Cortina

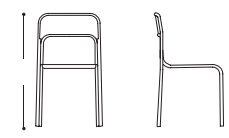

seat / assise: 370 seat / assise: 380



Stacking / Empilabilité
max 8 pieces / maximum 8 pièces

Metal elements
Finition tubes



plastic + metal / plastique + métal



Finisings used at the arrangement:
chairs: K-11 (red), K-19 (blue), K-18 (yellow)

Finitions présentées dans cette page:
sièges: K-11 (rouge), K-19 (bleu), K-18 (jaune)

Golf

A folding chair with a powder coated metal frame, and a plastic seat and backrest.
Easy to clean and wash. When folded it is so thin that it can be stored anywhere
even behind a door. Excellent for use on balconies.
Siège pliante avec structure en métal époxy avec assise et dossier plastique.
Lavable. Stockage aisé compte tenu des faibles dimensions de cette siège une fois plié.



Golf

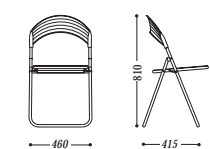

mat / matier: 395 mat / matier: 395

Metal elements
Finition tubes



BAR STOOLS
TABOURETS DE BAR



Bar stools | Tabourets de bar

KONTORSENTRET

CONTENT SYNTHÈSE



Adria Hocker
page 156

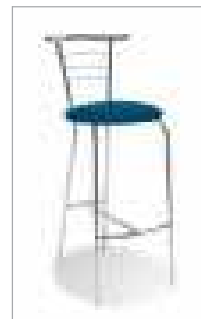

Arancia Hocker
page 168

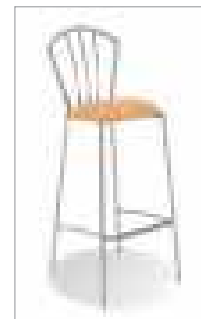

Azzurro Hocker
page 172



Baleno Hocker 
page 146



Bistro Hocker
page 138



Caldo Hocker 
page 162

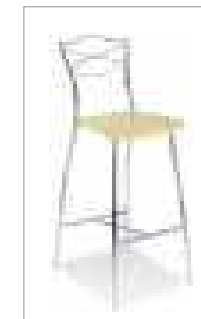

Dolce Hocker 
page 144



Dolly Hocker
page 158



Fianna Hocker 
page 140



Giallo Hocker
page 176



Grigio Hocker
page 164



Jola
page 148



Molino Hocker
page 142



Neron Hocker
page 170



Retro
page 178

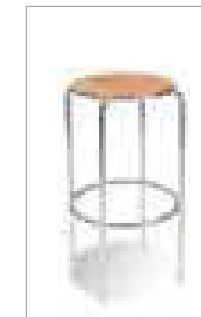

Ringo Hocker
page 160



Rosso Hocker
page 174



Tiziano Hocker 
page 166



Tilipan Hocker
page 154



Vega Hocker
page 152



Venus Hocker
page 150



Zeta
page 180

wood + upholstery + metal

/ bois + tapisserie + métal



Finishings used at the arrangement:
chairs: wood 1.033, chrome
Bistro 1100 Table: chrome
table top: werzalit® W055, Ø 60 cm

Finitions présentées dans cette page:
sièges: bois 1.033, chrome
Bistro 1100 Table: chrome
plateau: werzalit® W055, Ø 60 cm

Bistro 1100 Table
page 204



The **Bistro** line consists of:
Ligne **Bistro** composée de:



Bistro Hocker

presented on this page
tableaux de bar présentés
sur cette page



Bistro

page 38



Bistro Table

page 204

Bistro Hocker

/ Projet: hermann + stump • ulm



Bistro Hocker - a swivel bar stool with a base consisting of black cast iron foot and a chromium plated or powder coated metal frame. Also with a soft upholstered seat in plus version.
Bistro 78 - a bar stool with a hinged seat compatible with kitchen tops and bars.

Tibouret de bar pivotant Bistro Hocker composé d'un socle en fonte époxy noire et d'un tube en métal chromé ou époxy assise et dossier en hêtre multipli. En version "plus", assise rembourrée tapissée.
En version "78", hauteur d'assise correspondant au niveau d'un bar ou d'un plan de travail en cuisine.

Design



Bistro Hocker chrome

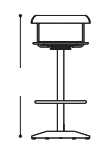

seat / assise: Ø 400



Bistro 78 chrome

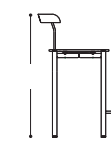

seat / assise: Ø 430



Bistro 78 chrome plus

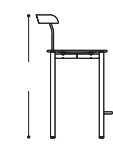

seat / assise: Ø 430

Metal elements
Finition tubes

alu

chrome



Bar stools | Tabourets de bar

wood + upholstery + metal

/ bois + tapisserie + métal



A bar stool with a chromium plated or powder coated metal frame, with a plywood seat in wood version. Also available with a soft upholstered seat. In the 78 version hinged seat can be used with kitchen counters and bars.

Tibourets de bar avec structure et dossier en métal chromé ou époxy. En version "plus", assise rembourrée tapissée. En version "wood", assise en hêtre multipli. En version "78", hauteur d'assise correspondant au niveau d'un bar ou d'un plan de travail en cuisine.

Fiamma Hocker

Design

| Projet: Malgorzata Pe kala



4 Finishing used at the arrangement:
chairs wood 1.031, alu
Finitions présentées dans cette page:
sièges bois 1.031, alu

The Fiamma line consists of:
Ligne Fiamma composée de:



Fiamma Hocker wood alu

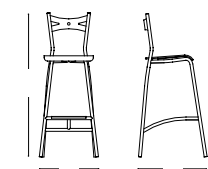

seat | assise: 370 seat | assise: 370



Fiamma 78 wood alu

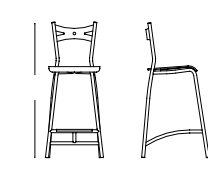

seat | assise: 370 seat | assise: 370



Fiamma 78 alu
page 44

Metal elements
Finition tubes



Bar stools | Tibourets de bar

wood + upholstery + metal

/ bois + tapisserie + métal



Finisings used at the arrangement:
chairs: upholstery V47, chrome
Bistro 1100 Table: chrome
table top: werzalit W055, Ø 60 cm

Finitions présentées dans cette page:
sièges: tapisserie V47, chrome
Bistro 1100 Table: chrome
plateau: werzalit W055, Ø 60 cm

Bistro 1100 Table
page 204



The Molino line consists of:
Ligne Molino composée de:



Molino Hocker

presented on this page:
tabouret de bar présenté
sur cette page



Molino

page 46



Molino Table

page 202



Molino Duo Table

page 202

A bar stool with a chromium plated or powder coated metal frame and backrest,
with a soft upholstered seat in plus version, or plywood seat in wood version.
In the 78 version hinged seat can be used with kitchen counters and bars.

Tiibourets de bar avec structure et dossier en métal chromé ou époxy. En version "plus",
assise rembourrée tapissée. En version "wood", assise en hêtre multipli. En version "78",
hauteur d'assise correspondant au niveau d'un bar ou d'un plan de travail en cuisine.

Molino

Design

Hocker

/ Projet: Malgorzata Pe kala, Agata Danielak-Kujda



Molino Hocker wood chrome



seat | width: 395 seat | width: 415



Molino Hocker plus chrome



seat | width: 400 seat | width: 415

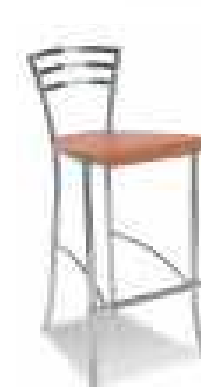

Molino 78 wood chrome

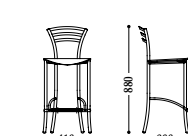

seat | width: 395 seat | width: 415



Molino 78 plus chrome



seat | width: 400 seat | width: 415

Metal elements
Finition tubes



Bar stools | Tabourets de bar

wood + upholstery + metal

/ bois + tapisserie + métal



A bar stool with a chromium plated or powder coated metal frame and backrest, with a plywood or soft upholstered seat. In the 78 version hinged seat can be used with kitchen counters and bars.

"Tabourets de bar avec structure et dossier en métal chromé ou époxy. En version "plus", assise rembourrée tapissée. En version "wood", assise en hêtre multiplié. En version "78", hauteur d'assise correspondant au niveau d'un bar ou d'un plan de travail en cuisine.

Dolce Hocker

Design

| Projet: Malgorzata Pe kala



4 Finishing used at the arrangement:
chairs: upholstery V47, chrome

Finitions présentées dans cette page:
siège: tapisserie V47, chrome

The Dolce line consists of:
Ligne Dolce composée de:



Dolce Hocker chrome

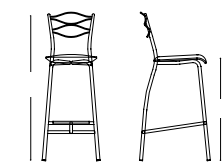

mat | assise: 300 mat | assise: 300

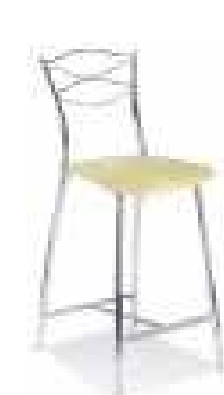

Dolce 78 chrome



mat | assise: 300 mat | assise: 300

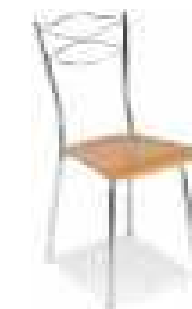

Dolce wood chrome
page 48

Metal elements
Finition tubes



Bar stools | Tabourets de bar

wood + upholstery + metal

/ bois + tapisserie + métal



A bar stool with a chromium plated or powder coated metal frame and backrest, with a plywood or soft upholstered seat. In the 78 version hinged seat can be used with kitchen counters and bars.

'Tabourets de bar avec structure et dossier en métal chromé ou époxy. En version "plus", assise rembourrée tapissée. En version "wood", assise en hêtre multipli. En version "78", hauteur d'assise correspondant au niveau d'un bar ou d'un plan de travail en cuisine.

Baleno

Hocker

Design

/ Projet: Wieslaw Radoniewicz

NEW

UNIQUE DESIGN



Finisings used at the arrangement:
chairs: wood 1.033, alu

Finitions présentées dans cette page:
sièges: bois 1.033, alu

The Baleno line consists of:
Ligne Baleno composée de:



Baleno Hocker wood alu



seat / assise: 378 seat / assise: 350



Baleno 78 wood alu



seat / assise: 378 seat / assise: 350



Baleno chrome
page 50

Metal elements
Finition tubes



KONTORSENTRET

Bar stools | Tabourets de bar

wood + upholstery + metal

/ bois + tapisserie + métal

Jola

A bar stool with a chromium plated or powder coated metal frame and backrest, and a soft upholstered or plywood seat.

Tibourets de bar avec structure et dossier en métal chromé ou époxy avec assise rembourrée tapissée. En version "wood", assise en hêtre multipli.



Bar stools | Tibourets de bar

Finishings used at the arrangement:
chairs: wood 1.008, chrome

Finitions présentées dans cette page:
sièges: bois 1.008, chrome



Jola chrome



Jola wood chrome

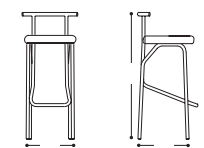

mat | matier: Ø 370

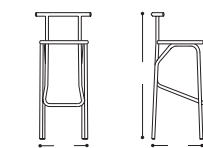

mat | matier: Ø 380

Metal elements
Finition tubes



wood + upholstery + metal

| bois + tapisserie + métal

A bar stool with a chromium plated or powder coated metal frame and backrest, and a soft upholstered or plywood seat. In the 78 version hinged seat can be used with kitchen counters and bars.

Tibourets de bar avec structure et dossier en métal chromé ou époxy avec assise rembourrée tapissée. En version "wood", assise en hêtre multipli. En version "78", hauteur d'assise correspondant au niveau d'un bar ou d'un plan de travail en cuisine.

Venus

Hocker



Finishings used at the arrangement:
chairs: wood 1.033, alu

Finitions présentées dans cette page:
sièges: bois 1.033, époxy aluminium

The Venus line consists of:
Ligne Venus composée de:



Venus Hocker

Venus

presented on this page
tabouret de bar présentés
sur cette page

page 60



Venus Hocker alu

Venus Hocker wood alu

Venus 78 alu

Venus 78 wood alu

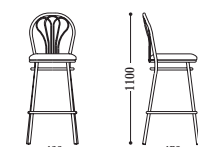

seat | assise: Ø 410



seat | assise: Ø 400

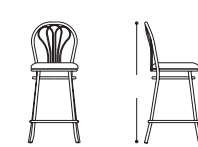

seat | assise: Ø 410

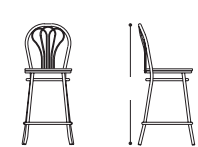

seat | assise: Ø 400

Metal elements
Finition tubes

alu



chrome



black



Bar stools | Tibourets de bar

wood + upholstery + metal

| bois + tapisserie + métal

Vega Hocker



Finishings used at the arrangement:
chairs wood 1.016, chrome

Finitions présentées dans cette page:
sièges bois 1.016, chrome

The Vega line consists of:
Ligne Vega composée de:



Vega Hocker

presented on this page
tabouret de bar présentés
sur cette page



Vega

page 52

A bar stool with a chromium plated or powder coated metal frame and backrest, and a soft upholstered or plywood seat. In the 78 version hinged seat can be used with kitchen counters and bars.

Tibourets de bar avec structure et dossier en métal chromé ou époxy avec assise rembourrée tapissée. En version "wood", assise en hêtre multipli. En version "78", hauteur d'assise correspondant au niveau d'un bar ou d'un plan de travail en cuisine.



Vega Hocker chrome

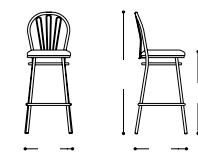

seat | assise: Ø 410



Vega Hocker wood chrome

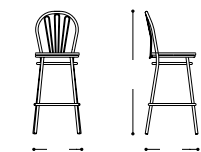

seat | assise: Ø 400



Vega 78 chrome

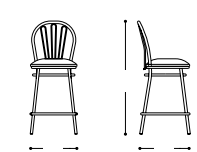

seat | assise: Ø 410



Vega 78 wood chrome

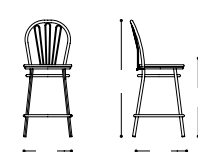

seat | assise: Ø 400

Metal elements
Finition tubes

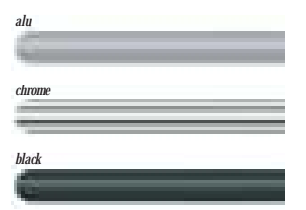

Bar stools | Tibourets de bar

wood + upholstery + metal

| bois + tapiserie + métal



Finishing used at the arrangement:
chairs wood 1.010, chrome

Finitions présentées dans cette page:
sièges bois 1.010, chrome

The Tulipan line consists of:
Ligne Tulipan composée de:



Tulipan Hocker

Tulipan

presented on this page
tabouret de bar présentés
sur cette page

page 62

A bar stool with a chromium plated or powder coated metal frame and backrest, and a soft upholstered or plywood seat. In the 78 version hinged seat can be used with kitchen counters and bars.

Tabourets de bar avec structure et dossier en métal chromé ou époxy avec assise rembourrée tapissée. En version "wood", assise en hêtre multipli. En version "78", hauteur d'assise correspondant au niveau d'un bar ou d'un plan de travail en cuisine.



Tulipan Hocker



Bar stools | Tabourets de bar



Tulipan Hocker chrome

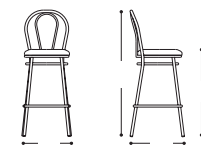

seat | width: Ø 410

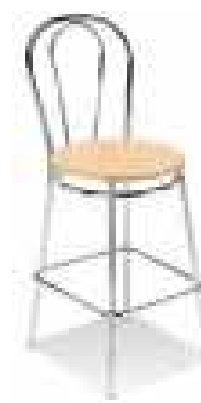

Tulipan Hocker wood chrome

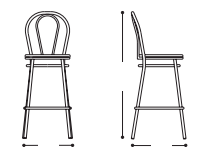

seat | width: Ø 400



Tulipan 78 chrome

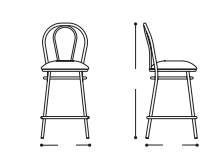

seat | width: Ø 410



Tulipan 78 wood chrome

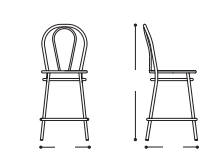

seat | width: Ø 400

Metal elements
Finition tubes

alu

chrome

black

wood + upholstery + metal

/ bois + tapisserie + métal



Finishings used at the arrangement:
chairs: upholstery V18, chrome

Finitions présentées dans cette page:
sièges: tapisserie V18, chrome

A bar stool with a chromium plated or powder coated metal frame and backrest,
and a soft upholstered or plywood seat.

Tabourets de bar avec structure et dossier en métal chromé ou époxy
avec assise rembourrée tapissée. En version "wood", assise en hêtre multipli.

Adria

Hocker



Finishings used at the arrangement:
chair: upholstery V29, chrome
Bistro 1100 Table chrome
table top: werzalit® W055, Ø 60 cm
Finitions présentées dans cette page:
siège: tapisserie V29, chrome
Bistro 1100 Table chrome
plateau: werzalit® W055, Ø 60 cm

Bistro 1100 Table
page 204



Adria Hocker chrome

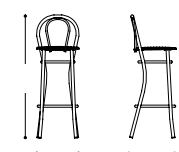

mat | color: Ø 370



Adria Hocker wood chrome

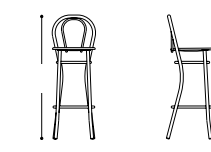

mat | color: Ø 360



Metal elements
Finition tubes

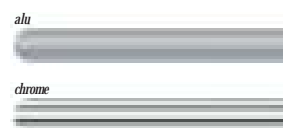



Finishings used at the arrangement:
chairs: wood 1.033, alu

Finitions présentées dans cette page:
sièges: wood 1.033, alu

The Dolly line consists of:
Ligne Dolly composée de:



Dolly Hocker

presented on this page
tabouret de bar présentés
sur cette page



Dolly

page 68



Dolly Stool

page 184



Dolly Table

page 212

A bar stool with a chromium plated or powder coated metal frame,
and a plywood seat and backrest.

Tibouret de bar avec structure en métal chromé ou époxy,
avec assise et dossier en hêtre multipli.

Dolly

Design

Hocker

Projet: Mikolaj Wierszyłowski



Dolly Hocker alu

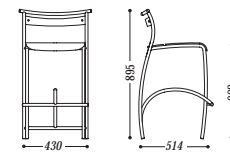

seat | assise: 300

seat | assise: 400

Metal elements
Finition tubes

alu

chrome



wood + metal / bois + métal



A bar stool with a chromium plated or powder coated metal frame, and a decorated plywood seat.

Tibouret de bar avec structure en métal chromé ou époxy avec assise en hêtre multipli.

Ringo

Hocker



Finishings used at the arrangement:
chairs: wood 1.033, chrome

Finitions présentées dans cette page:
sièges: bois 1.033, chrome

The Ringo line consists of:
Ligne Ringo composée de:



Ringo Hocker

presented on this page
tableau de bar présentés
sur cette page



Ringo

page 186



Ringo Hocker chrome



mat | anse: Ø 310

Metal elements
Finition tubes



Bar stools | Tabourets de bar

upholstery + metal

/ tapiserie + métal



A bar stool with a chromium plated or powder coated metal frame and backrest and a soft upholstered seat. In the 78 version hinged seat can be used with kitchen counters and bars.
 Tabourets de bar avec structure et dossier en métal chromé ou époxy avec assise rembourrée tapissée.
 En version 78, hauteur d'assise correspondant au niveau d'un bar ou d'un plan de travail en cuisine.

Caldo Hocker

Design

/ Projet: Mikołaj Wierszylowski



◀ Finishing used at the arrangement:
 chairs: upholstery V-19, chrome
 Finitions présentés dans cette page:
 sièges: tapiserie V-19, chrome

The Caldo line consists of:
 Ligne Caldo composée de:



Caldo Hocker chrome

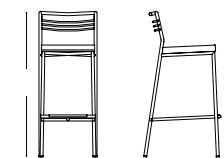

mat / anse: 380 mat / anse: 365



Caldo 78 chrome

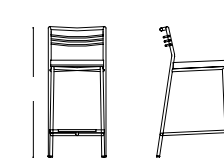

mat / anse: 380 mat / anse: 364



Caldo chrome page 92

Metal elements
Finition tubes



Bar stools | Tabourets de bar



Finishings used at the arrangement:
chairs: upholstery V18, chrome, wood 1.007

Finitions présentées dans cette page:
sièges: tapiserie V18, chrome, bois 1.007

The Grigio line consists of:
Ligne Grigio composée de:



Grigio Hocker

presented on this page
tabouret de bar présentés
sur cette page



Grigio

page 98

A bar stool with a chromium plated or powder coated metal frame and backrest, and a soft upholstered seat. Backrest with a wooden element. In the 78 version hinged seat can be used with kitchen counters and bars.

Tabouret de bar avec structure et dossier en métal chromé ou époxy avec assise rembourrée tapissée. En version 78, hauteur d'assise correspondant au niveau d'un bar ou d'un plan de travail en cuisine.



Grigio Hocker



Bar stools | Tabourets de bar



Grigio Hocker alu

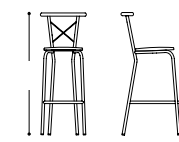

seat | width: Ø 410



Grigio 78 alu

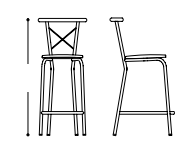

seat | width: Ø 410

Metal elements
Finition tubes

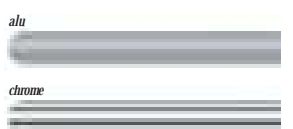

upholstery + metal

/ tapiserie + métal



A bar stool with a chromium plated or powder coated metal frame and backrest, soft upholstered seat and element in the backrest. In the 78 version hinged seat can be used with kitchen counters and bars.

Chaise avec structure en métal époxy assise et dossier rembourrés tapisés. En version 78, hauteur d'assise correspondant au niveau d'un bar ou d'un plan de travail en cuisine.

Tiziano Hocker

Design

| Projet: *Mikołaj Wierzyłowski*



◀ *Finishings used at the arrangement:*
chairs upholstery V18, chrome
Finitions présentées dans cette page:
sièges tapiserie V18, chrome

The Tiziano line consists of:
Ligne Tiziano composée de:



Tiziano Hocker chrome

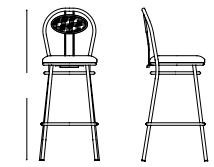

mat | color: 0 410



Tiziano 78 chrome

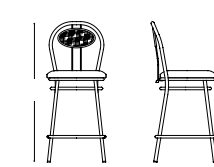

mat | color: 0 410



Tiziano chrome
page 90

Metal elements
Finition tubes



Bar stools | Tabourets de bar

upholstery + metal / tapiserie + métal



Finishings used at the arrangement:
chairs: upholsteryV18, chrome

Finitions présentées dans cette page:
sièges: tapiserieV18, chrome

The Arancia line consists of:
Ligne Arancia composée de:



Arancia Hocker

Arancia

presented on this page
tabouret de bar présentés
sur cette page

page 100

A bar stool with a chromium plated or powder coated metal frame and backrest, and a soft upholstered seat. In the 78 version hinged seat can be used with kitchen counters and bars.
Tabouret de bar avec structure et dossier en métal chromé ou époxy avec assise rembourrée tapissée. En version 78, hauteur d'assise correspondant au niveau d'un bar ou d'un plan de travail en cuisine.



Arancia Hocker chrome

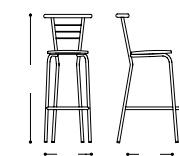

seat | assise: Ø 410

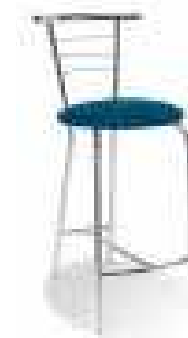

Arancia 78 chrome

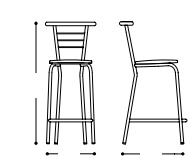

seat | assise: Ø 410

Metal elements
Finition tubes



Arancia Hocker



Finishings used at the arrangement:
chairs: upholsteryV17, chrome

Finitions présentées dans cette page:
sièges: tapisserieV17, chrome

The Neron line consists of:
Ligne Neron composée de:

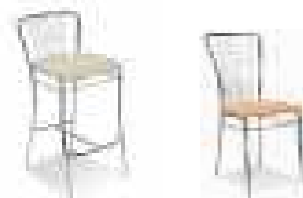

Neron Hocker

Neron

presented on this page
tabouret de bar présentés
sur cette page

page 110

A bar stool with a chromium plated or powder coated metal frame and backrest, and a soft upholstered seat. In the 78 version hinged seat can be used with kitchen counters and bars.

Tabouret de bar avec structure et dossier en métal chromé ou époxy avec assise rembourrée tapissée. En version "78", hauteur d'assise correspondant au niveau d'un bar ou d'un plan de travail en cuisine.



Neron Hocker



Neron Hocker chrome

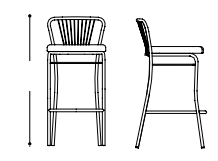

seat | assise: 430 seat | assise: 430



Neron 78 chrome

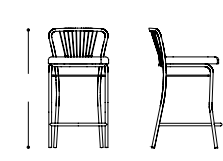

seat | assise: 430 seat | assise: 430

Metal elements
Finition tubes

alu

chrome



For more information about finishings see our finishing cards
Pour plus d'informations sur les finitions disponibles, se reporter à notre manuel

upholstery + metal

/ tapiserie + métal

Azzurro Hocker

A bar stool with a chromium plated or powder coated metal frame and backrest, and a soft upholstered seat. In the 78 version hinged seat can be used with kitchen counters and bars.
Tabouret de bar avec structure et dossier en métal chromé ou époxy avec assise rembourrée tapissée. En version "78", hauteur d'assise correspondant au niveau d'un bar ou d'un plan de travail en cuisine.



Bar stools | Tabourets de bar

Finishing used at the arrangement:
chairs: upholstery V18, chrome

Finitions présentées dans cette page:
sièges: tapiserie V18, chrome

The Azzurro line consists of:
Ligne Azzurro composée de:



Azzurro Hocker

Azzurro

presented on this page
Tabouret de bar présentés
sur cette page

page 102

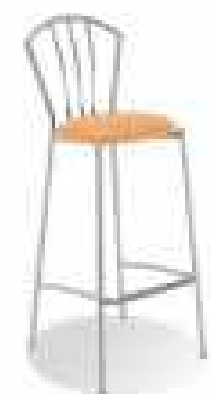

Azzurro



Hocker alu

Azzurro 78 alu

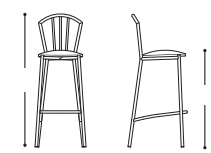

seat | assise: Ø 370

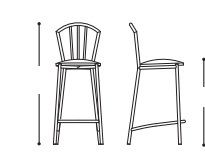

seat | assise: Ø 370

Metal elements
Finition tubes



upholstery + metal

/ tapisserie + métal

Rosso Hocker

A bar stool with a chromium plated or powder coated metal frame and backrest, and a soft upholstered seat. In the 78 version hinged seat can be used with kitchen counters and bars.
Tabouret de bar avec structure et dossier en métal chromé ou époxy avec assise rembourrée tapissée. En version "78", hauteur d'assise correspondant au niveau d'un bar ou d'un plan de travail en cuisine.



Bar stools | Tabourets de bar

Finisings used at the arrangement:
chairs: upholstery V27, chrome

Finitions présentées dans cette page:
sièges: tapisserie V27, chrome

The Rosso line consists of:
Ligne Rosso composée de:



Rosso Hocker

Rosso

presented on this page
tabouret de bar présentés
sur cette page

page 106



Rosso Hocker alu

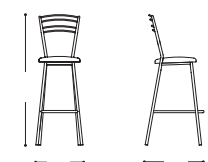

seat | anse: Ø 370



Rosso 78 alu



seat | anse: Ø 370

Metal elements
Finition tubes

alu

chrome



Finishings used at the arrangement:
chair: upholstery V27, chrome

Finitions présentées dans cette page:
siège: tapisserie V27, chrome

The Giallo line consists of:
Ligne Giallo composée de:



Giallo Hocker

presented on this page
tabouret de bar présentés
sur cette page



Giallo

page 108

A bar stool with a chromium plated or powder coated metal frame and backrest, and a soft upholstered seat. In the 78 version hinged seat can be used with kitchen counters and bars.
Tabouret de bar avec structure et dossier en métal chromé ou époxy avec assise rembourrée tapissée.
En version 78, hauteur d'assise correspondant au niveau d'un bar ou d'un plan de travail en cuisine.

Giallo Hocker



Giallo Hocker chrome

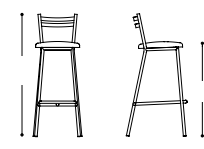

seat | anode: Ø 370



Giallo 78 chrome

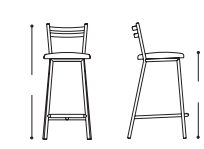

seat | anode: Ø 370

Metal elements
Finition tubes

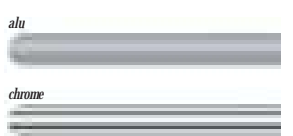

upholstery + metal / tapiserie + métal



Finishings used at the arrangement:
chairs upholstery V-16, chrome

Finitions présentées dans cette page:
sièges tapiserie V-16, chrome

A bar stool with a chromium plated metal frame,
and a soft upholstered seat. Rotating seat available in Twist version.
Tabourets de bar avec structure en métal chromé,
avec assise rembourrée tapissée. En version Twist, assise pivotante.



Retro



Retro Twist



seat / assise: Ø 360



seat / assise: Ø 360

530

Metal elements
Finition tubes



Retro

Bar stools | Tabourets de bar

upholstery + metal

/ tapiserie + métal

Zeta



Finishing used at the arrangement:
chairs: upholstery V27, chrome
Bistro 1100 Table: chrome
table top: werzalit® W055, Ø 60 cm

Finitions présentées dans cette page:
siège: tapiserie V27, chrome
Bistro 1100 Table: chrome
plateau: werzalit® W055, Ø 60 cm

Bistro 1100 Table
page 204



A bar stool with a chromium plated or powder coated metal frame,
and a soft upholstered seat.

Tibourets de bar avec structure en métal chromé,
avec assise rembourrée tapissée.



Bar stools | Tibourets de bar



Zeta



Zeta 425



Metal elements
Finition tubes

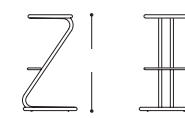

mat / code: 0340

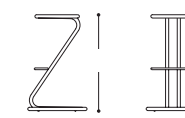

mat / code: 0340

STOOLS
TABOURETS



Stools | Tabourets



Finishings used at the arrangement:
 chairs and stool: wood 1.031, alu
 Dolly Table: alu
 table top: werzalit® W052, Ø 90 cm

Finitions présentées dans cette page:
 sièges et tabouret: bois 1.031, epoxy aluminium
 Dolly Table: epoxy aluminium
 plateau: werzalit® W052, Ø 90 cm

Dolly Table 380
 page 212



The Dolly line consists of:
 Ligne Dolly composée de:



Dolly Stool Dolly Dolly Hocker Dolly Table

presented on this page / tabourets présentés sur cette page
 page 68 page 158 page 212

A stool with a chromium plated or powder coated metal legs and a plywood seat.

Tabouret avec structure en métal chromé ou époxy avec assise en hêtre multipli.



Dolly Stool

Design / Projet: Mikolaj Wierszylowski



Dolly Stool alu

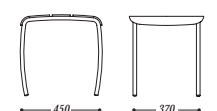

mat / color: 450 mat / color: 465

Metal elements
 Finition tubes

alu

chrome

Stools | Tabourets



A stool with a chromium plated or powder coated metal legs and a decorated plywood seat.
Tabouret avec structure en métal chromé ou époxy, avec assise en hêtre multipli.



Finishing used at the arrangement:
stools: wood 1.010, chrome

Finitions présentées dans cette page:
tabourets: bois 1.010, chrome

The Ringo line consists of:
Ligne Ringo composée de:



Ringo

presented on this page
tabourets présentés sur cette page



Ringo Hocker

page 160



Ringo chrome



Stacking/ Empilabilité
max 8 pieces/ maximum 8 pièces

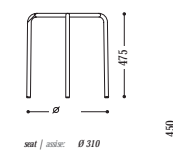

mat / mat: Ø 310

Metal elements
Finition tubes



Harpo

wood + upholstery + metal
bois + tapisserie + métal

A stool with a chromium plated or powder coated metal legs,
a soft upholstered or plywood seat.

"Tabouret avec structure en métal chromé ou époxy avec assise rembourrée tapissée.
En version "wood", assise en hêtre multipli.



Harpo chrome



Harpo wood chrome

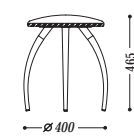

seat | assise: Ø 385

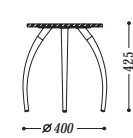

seat | assise: Ø 380

Metal elements
Finition tubes



wood + upholstery + metal
bois + tapisserie + métal

A stool with a chromium plated or powder coated metal legs,
a soft upholstered or plywood seat.

"Tabouret avec structure en métal chromé ou époxy avec assise rembourrée tapissée.
En version "wood", assise en hêtre multipli.



Grappo chrome



Stacking | Empilabilité
max 6 pieces | maximum 6 pièces



seat | assise: Ø 340

Metal elements
Finition tubes



Grappo



upholstery + metal / tapisserie + métal

A stool with a chromium plated or powder coated metal legs and a soft upholstered seat.
 Tabouret avec structure en métal chromé ou époxy avec assise rembourrée tapissée.



Zeppo chrome

Stacking / Empilabilité
 max 6 pieces / maximum 6 pièces

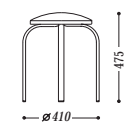

mat | assise: Ø 340

upholstery + metal / tapisserie + métal

A stool with a chromium plated or powder coated metal legs and a soft upholstered seat.
 Tabouret avec structure en métal chromé ou époxy avec assise rembourrée tapissée.



Chico chrome

Stacking / Empilabilité
 max 6 pieces / maximum 6 pièces

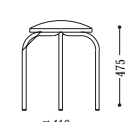

mat | assise: Ø 340

Chico

Stools | Tabourets

Metal elements
 Finition tubes



Metal elements
 Finition tubes

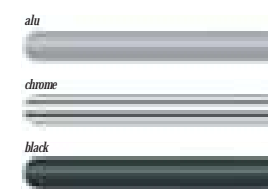

TABLES
TABLES



Alphabetical order / Ordre alphabétique

CONTENT SYNTHÈSE



Bistro Table
page 204



Bistro 1100 Table
page 204



Cafe Table
page 220



Claudia Table ★ NEW
page 222



Dorino Duo Table
page 200



Florida
page 226



Gala
page 213



Harlekin Table
page 196



Melba Table
page 206



Melba Duo Table
page 206



Milena Table ★ NEW
page 198



Molino Table
page 202



Tiramisu Table
page 208



Tiramisu Duo Table
page 208



Tacy
page 210



Tacy Duo
page 210



Dolly Table 380
page 212



Dona-3
page 218



Dona-4
page 218



Dorino Table
page 200



Kaja
page 216



Karina
page 217



Lena
page 224



Lena 1100
page 224



Molino Duo Table
page 202



Rico Table
page 225



Rozana
page 214



Sonia
page 215



Wiktor
page 221



Wiktor 1100
page 221

Harlekin

Table

Design / Projet: hermann + stupp • ulm



A solid wooden table with a wooden veneer table top.
Table en bois avec plateau recouvert d'un placage en bois naturel.



Finishings used at the arrangement:
chairs: wood 1.010, upholstery EF-019
Harlekin Table: wood 1.010

Finitions présentées dans cette page:
sièges: bois 1.010, tapiserie EF-019
Harlekin Table: bois 1.010

Harlekin
page 18



The Harlekin line consists of:
Ligne Harlekin composée de:



Harlekin
Table
presented on this page
table présentée sur cette page



Harlekin
Chair
page 18



Harlekin
page 18



Harlekin Table

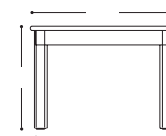

Milena Table

 NEW



A table base made of metal foot and single wooden leg, only in beech colour
 Compatible with Wezalit, melamine board and with natural lining table tops
 Piétement constitué d'une base ronde en fonte et d'un tube central en bois.
 Ce piétement peut recevoir un plateau mélaminé, en Wezalit ou être recouvert
 d'un placage en bois naturel.

« Finitions used at the arrangement:
 chairs: upholstery SE-03, chrome
 Milena Table wood 1.007, alu
 table top: MA-NN, Ø 80 cm
 Finitions présentées dans cette page:
 sièges: tapiserie SE-03, chrome
 Milena Table wood 1.007, alu
 table top: MA-NN, Ø 80 cm

Baleno
 page 50



Milena Table alu

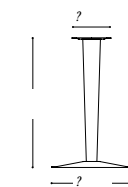

Metal elements
 Finition tubes



Dorino Table, Dorino Duo Table

Design / Projet: Malgorzata Pe kala, Agata Danielak-Kujda



A table with a base consisting of chromium plated or powder coated metal legs and solid wooden framework. The table top is lined with a natural veneer.
 Piétement de table constitué de quatre tubes galbés chromés ou époxy aluminium.
 Coiffure d'encadrement en bois coloris identique au plateau.
 Surface du plateau recouverte d'un placage en bois naturel.



Finishings used at the arrangement:
 chairs: wood 1.033, alu
 Dorino Table: alu
 table top: ON 1.033, 120x80 cm

Finitions présentées dans cette page:
 sièges: bois 1.033, epoxy aluminium
 Dorino Table: epoxy aluminium
 plateau: ON 1.033, 120x80 cm

Dorino
 page 36



The Dorino line consists of:
 Ligne Dorino composée de:



Dorino

Table



Dorino

Duo Table



Dorino

presented on this page
 table présentée sur cette page

page 36



Dorino Table alu

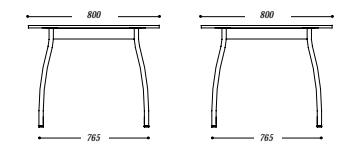

Dorino Duo Table alu

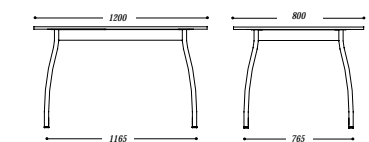

Metal elements
 Finition tubes



Molino Table, Molino Duo Table

Design | Projet: Malgorzata Pe kala, Agata Daniełak-Kujda



A table base made of chromium plated or powder coated metal legs
Compatible with Werzalit, melamine board and with natural lining table tops
Piétement constitué de quatre tubes chromés ou époxy aluminium.
Ce piétement peut recevoir un plateau en Werzalit ou recouvert d'un placage en bois naturel.



Finishings used at the arrangement:
chairs: wood 1.033, alu
Molino Table: alu
table top: werzalit-W070, 120x80 cm

Finitions présentées dans cette page:
sièges: bois 1.033, époxy aluminium
Molino Table: époxy aluminium
plateau: werzalit-W070, 120x80 cm

Molino
page 46



The Molino line consists of:
Ligne Molino composée de:



Molino Table

presented on this page
table présentée sur cette page



Molino Duo Table



Molino

page 46



Molino Hocker

page 142



Molino Table alu

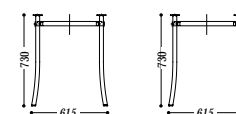

Molino Duo Table alu

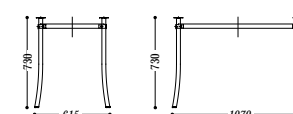

Metal elements
Finition tubes

alu

chrome

Bistro Table, Bistro 1100 Table

Design | Projet: hermann + stumpf • ulm



A table base made of cast iron foot in black metal plate cover and single leg made of three chromi- um plated or powder coated metal tubes. Compatible with Verzalit, melamine board and with natural lining table tops.

Piècemen de table composé d'une base ronde en fonte se prolongeant par une colonne constituée de trois tubes en métal finition époxy aluminium ou chromée. Ce piècemen peut recevoir un plateau en Verzalit ou recouvert d'un placage en bois naturel.



Finisings used at the arrangement:
chairs: wood 1.033, chrome
Bistro 1100 Table: chrome
table top: verzalit-W055, Ø 60 cm

Finitions présentées dans cette page:
sièges: bois 1.033, chrome
Bistro 1100 Table: chrome
plateau: verzalit-W055, Ø 60 cm

Bistro

page 138

Hocker



The Bistro line consists of:
Ligne Bistro composée de:



Bistro Table



Bistro 1100 Table



Bistro

page 38



Bistro Hocker

page 138

presented on this page
base de table présentée sur cette page



Bistro Table chrome

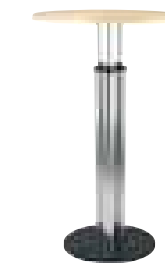
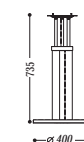

Bistro 1100 Table chrome

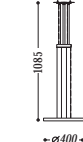

Metal elements
Finition tubes

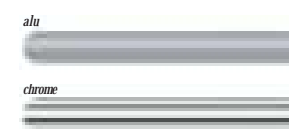



Finishings used at the arrangement:
 chair: wood 3.098, alu
 Melba Table: alu
 table top: werzalit® W074, 80x80 cm

Finitions présentées dans cette page:
 siège: bois 3.095, alu
 Melba Table: alu
 plateau: werzalit® W074, 80x80 cm

Medea
 page 70



Melba

Melba Table, Melba Duo Table

*A table base made of chromium plated or powder coated metal legs.
 Compatible with Werzalit, melamine board and with natural lining table tops.*

*Piètement constitué de quatre tubes finition chromée ou époxy aluminium.
 Ce piètement peut recevoir un plateau en Werzalit ou recouvert d'un placage en bois naturel.*



Table alu



Melba Table 80 alu



Melba Duo Table alu

*Metal elements
 Finition tubes*

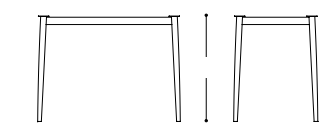
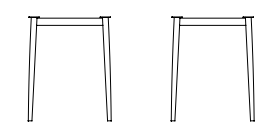
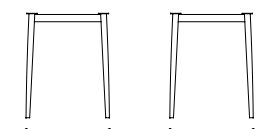



Finishings used at the arrangement:
 chairs: upholstery V18, chrome
 table: Facy, chrome
 table top: MA-NN, Ø 80 cm

Finitions présentées dans cette page:
 sièges: tapisserie V18, chrome
 table: Facy, chrome
 plateau: MA-NN, Ø 80 cm

Azzurro
 page 102



Tiramisu Table, Tiramisu

Duo Table

A table base made of chromium plated or powder coated metal legs.
 Compatible with Wezalit, melamine board and with natural lining table tops.
 Piètement constitué de quatre tubes finition chromée ou époxy aluminium.
 Ce piètement peut recevoir un plateau en Wezalit ou recouvert d'un placage en bois naturel.



Tiramisu Table chrome



Tiramisu Duo Table chrome

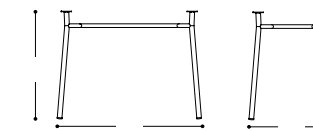
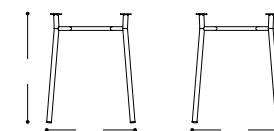

Metal elements
 Finition tubes



Tracy, Tracy Duo



Finishing used at the arrangement:
chairs: upholstery V04, chrome
table Tracy: chrome
table top: werzalit W014, Ø 80 cm

Finitions présentées dans cette page:
sièges: tapiserie V04, chrome
table Tracy: chrome
plateau: werzalit W014, Ø 80 cm

Rosso
page 106



*A table base made of chromium plated or powder coated metal legs.
Compatible with Werzalit, melamine board and with natural lining table tops.*
Piétement constitué de quatre tubes finition chromée ou époxy aluminium
reliés par des traverses en métal. Ce piétement peut recevoir un plateau en mélaminé,
en Werzalit ou recouvert d'un placage en bois naturel.



Tracy chrome



Tracy Duo chrome

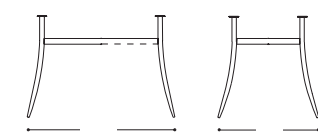
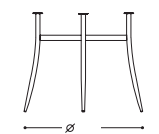

Metal elements
Finition tubes



Dolly Table 380

Design / Projet: Mikolaj Wierszyllowski



metal / métal

A table base made of chromium plated or powder coated metal legs.
Compatible with Wezali, melamine board and with natural lining table tops.

Piètement constitué de deux tubes reliés entre eux par un tube central, en finition chromée ou époxy.
Ce piètement peut recevoir un plateau en mélaminé, en Wezaliit ou recouvert d'un placage en bois naturel.

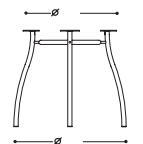

Metal elements
Finition tubes

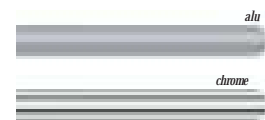

The Dolly line consists of:
Ligne Dolly composée de:



Dolly Table

Dolly Hocker

Dolly

Dolly Stool

presented on this page
présenté de lui présents
sur cette page

page 158

page 66

page 184

metal / métal

A table base made of chromium plated or powder coated metal legs.
Compatible with Wezali, melamine board and with natural lining table tops.

Piètement constitué de deux tubes reliés entre eux par un tube central, en finition chromée ou époxy.
Ce piètement peut recevoir un plateau en mélaminé, en Wezaliit ou recouvert d'un placage en bois naturel. Bâtons réglables permettant l'ajustement de la stabilité de la table sur le sol.



Adjustable glides

Bâtons réglables permettant
l'ajustement de la stabilité
de la table sur le sol



Gala chrome

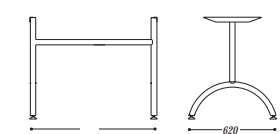

Metal elements
Finition tubes

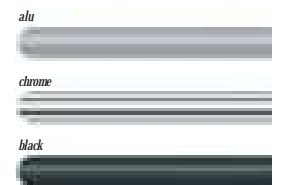

Rozana

metal / métal

A table base made of chromium plated or powder coated metal legs.
Compatible with glass, Verzalit, melamine board and with natural lining table tops.
Piétement constitué de quatre tubes finition chromée ou époxy aluminium.
Ce piétement peut recevoir d'un plateau en verre, un plateau en mélaminé,
en Verzalit ou recouvert de placage en bois naturel.



Rozana chrome

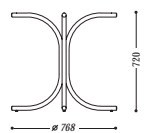

Metal elements
Finition tubes



metal / métal

A table base made of chromium plated or powder coated metal legs.
Compatible with glass, Verzalit, melamine board and with natural lining table tops.
Piétement constitué de quatre tubes finition chromée ou époxy aluminium.
Ce piétement peut recevoir d'un plateau en verre, un plateau en mélaminé,
en Verzalit ou recouvert de placage en bois naturel.



Sonia 740 chrome

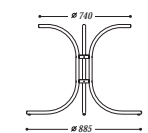

Sonia 840 chrome

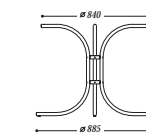

Metal elements
Finition tubes



Kaja

metal / métal

A table base made of chromium plated or powder coated metal legs.
Compatible with Werzalit, melamine board and with natural lining table tops.

Piètement constitué de quatre tubes finition chromée ou époxy noir. Ce piètement peut recevoir un plateau en mélaminé, en Werzalit ou recouvert d'un placage en bois naturel.



metal / métal

Karina

A table base made of chromium plated or powder coated metal legs.
Compatible with Werzalit, melamine board and with natural lining table tops.

Piètement constitué de quatre tubes reliés entre eux, finition chromée ou époxy noir. Ce piètement peut recevoir un plateau en mélaminé, en Werzalit ou recouvert d'un placage en bois naturel.

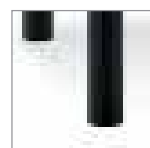

Adjustable glides
Patins réglables permettant l'ajustement de la stabilité de la table sur le sol

Kaja Ø 60
Kaja Ø 60/775



Kaja Ø 50 black

Kaja Ø 60

Kaja Ø 60/775

Range of glide adjusting: 50 mm
Amplitude de réglage des patins: 50 mm

Range of glide adjusting: 50 mm
Amplitude de réglage des patins: 50 mm

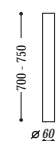
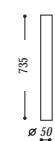

Metal elements
Finition tubes



Karina chrome

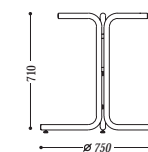

Metal elements
Finition tubes



Dona -3, Dona-4



Finishings used at the arrangement:
 chairs: upholstery V-13, alu
 table Dona-3: alu
 table top: werzalit W074, Ø 60 cm

Finitions présentées dans cette page:
 sièges: tapiserie V-13, alu
 table Dona-3: alu
 plateau: werzalit W074, Ø 60 cm

Rosso
 page 106



A table base made of chromium plated or powder coated metal legs.
 Compatible with Werzalit, melamine board and with natural lining table tops.
 Piétement constitué de quatre tubes finition chromée ou époxy aluminium.
 Ce piétement peut recevoir un plateau en mélaminé, en Werzalit ou recouvert
 d'un placage en bois naturel.

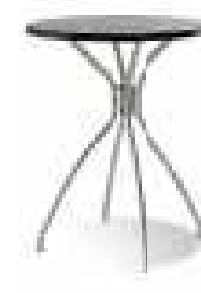

Dona-3 alu

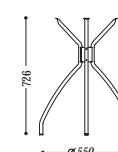

Dona-4 chrome

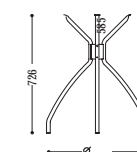

Metal elements
 Finition tubes



Café Table

metal / métal

A table base made of chromium plated or powder coated metal legs.
Compatible with Werzalit, melamine board and with natural lining table tops.
Piétement constitué d'une base tube à 4 branches et d'un tube central.
Finition chromée ou époxy aluminium. Ce piétement peut recevoir un plateau en mélaminé, en Werzalit ou recouvert d'un placage en bois naturel.



metal / métal

A table base made of chromium plated or powder coated metal legs.
Compatible with Werzalit, melamine board and with natural lining table tops.
Piétement constitué d'une base tube à 4 branches et d'un tube central.
Finition chromée ou époxy aluminium. Ce piétement peut recevoir un plateau en mélaminé, en Werzalit ou recouvert d'un placage en bois naturel.



,Wiktor 1100

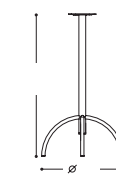
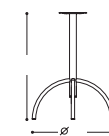

Metal elements
Finition tubes

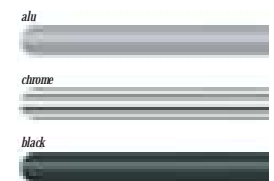

Tables | Tables

Metal elements
Finition tubes



The Café line consists of:
Ligne Café composée de:

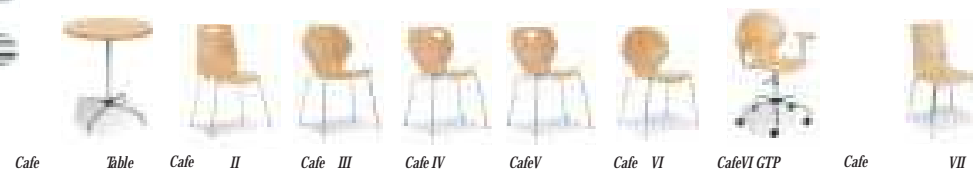

Café Table Café II Café III Café IV Café V Café VI Café VI GTP Café VII

presented on this page table présentée sur cette page

page 74

page 76

page 78

page 80

page 40

for more information see our „OFFICE“ catalogue
Complément d'information sur les pièces de liaison des sièges : catalogue „OFFICE“

page 82

metal / métal

Claudia Table

 NEW



A table base made of chromium plated or powder coated metal legs.
Compatible with Wezalit, melamine board and with natural lining table tops.
Piétement constitué de quatre tubes finition chromée ou époxy aluminium.
Ce piétement peut recevoir un plateau en Wezalit ou recouvert d'un placage en bois naturel.

Finishings used at the arrangement:
chairs: wood 1.007, chrome
Claudia Table: chrome
table top: MA-NR 80x80 cm
Finitions présentées dans cette page:
sièges: bois 1.007, chrome
Claudia Table: chrome
plateaux: MA-NR 80x80 cm

CafeV
page 80



Claudia Table chrome

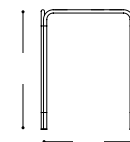

Metal elements
Finition tubes



Tables | Tables

Lena, Lena 1100

metal / métal

A table base made of the powder coated cast iron foot and single leg made of chromium plated or powder coated metal tube. Compatible with Wezzalit, melamine board and with natural lining table tops.

Piètement constitué d'une base ronde en fonte et d'un tube central en acier. Ce piètement peut recevoir un plateau en mélaminé, en Wezzalit ou recouvert d'un placage en bois naturel.



Lena chrome

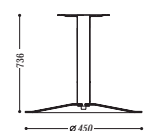

Lena 1100 chrome



Metal elements
Finition tubes



metal / métal

Rico Table

A folding conference table with a powder coated metal frame. The table top, available in three sizes, is made of a melaminated chipboard, available only in a beech colour. Tables are stackable.

Table pliante, pour conférences et banquets, avec piètement et cadre de renfort en métal époxy. Plateau en particules, finition en mélaminé coloris hêtre, disponible en trois dimensions. Peut être stockée en pile.



Rico Table-2 alu

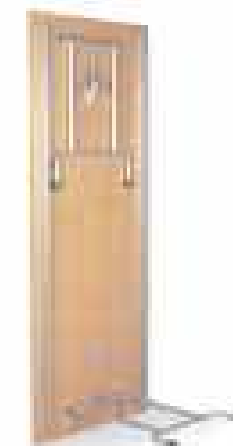

The tables can be stacked
Les tables peuvent être stockées en pile

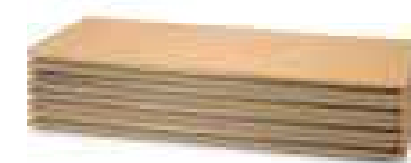

Rico Table-2

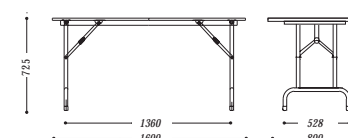

Rico Table-3

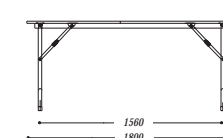

Rico Table-4

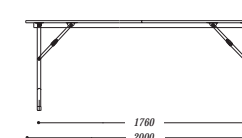

Metal elements
Finition tubes



A table bases consisting of a leg made of a chromium plated or powder coated metal tube and powder coated cast iron foot. Compatible with Werzalit table tops.
Piètement composé d'une base en fonte et d'un tube central en métal chromé ou époxy. Ce piètement peut recevoir un plateau en Werzalit.



FLORIDA
index: 01G45A/70A
base: Ø 450 alu
leg: 700 alu



FLORIDA
index: 01G45B/70B
base: Ø 450 black
leg: 700 black



FLORIDA
index: 01G45B/70C
base: Ø 450 alu
leg: 700 chrome



FLORIDA
index: 01G52A/70A
base: Ø 520 alu
leg: 700 alu



FLORIDA
index: 01S45A/70A
base: Ø 450 alu
leg: 700 alu

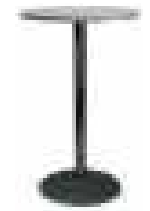

FLORIDA
index: 01G52B/105B
base: Ø 520 black
leg: 1050 black



FLORIDA
index: 01G52B/105BR
base: Ø 520 black
leg: 1050 black ring



FLORIDA
index: 01G52B/105C
base: Ø 520 black
leg: 1050 chrome

base shape:

forme:

- 01 - round / rond
- 02 - square / carré
- 03 - oval / ovale
- 04 - foot / pied 590x170

base surface:

surface:

- G - smooth / poli
- S - ribbed / strié

base colours:

couleurs de base:

- A - alu / alu
- B - black / noire

leg size:

dimensions du piètement:

- 70 - 700 mm
- 105 - 1050 mm

leg colours:

couleurs de tube central:

- A - alu / alu
- B - black / noire
- C - chrome / chrome

ring base:

- G - smooth / poli
- S - ribbed / strié

base dimensions:

dimensions de base:

- 45 - ø 450 or 450x450
- 52 - ø 520 or 520x520
- 59 - 590x170
- 68 - 680x400



FLORIDA
index: 01S45B/70B
base: Ø 450 black
leg: 700 black



FLORIDA
index: 01S45B/70C
base: Ø 450 black
leg: 700 chrome



FLORIDA
index: 01S52A/70A
base: Ø 520 alu
leg: 700 alu



FLORIDA
index: 01S52B/70B
base: Ø 520 black
leg: 700 black



FLORIDA
index: 01S52B/70C
base: Ø 520 black
leg: 700 chrome

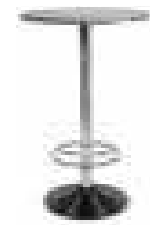

FLORIDA
index: 01G52B/105CR
base: Ø 520 black
leg: 1050 chrome ring

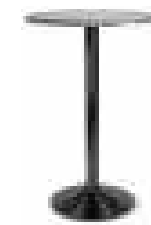

FLORIDA
index: 01S52B/105B
base: Ø 520 black
leg: 1050 black



FLORIDA
index: 01S52B/105BR
base: Ø 520 black
leg: 1050 black ring



FLORIDA
index: 02S45A/70A
base: 450x450 alu
leg: 700 alu



FLORIDA
index: 02S45B/70B
base: 450x450 black
leg: 700 black



FLORIDA
index: 02S45B/70C
base: 450x450 black
leg: 700 chrome



FLORIDA
index: 03S68B/70C
base: 680x400 black
leg: 700 chrome



FLORIDA
index: 03S68B/105BR
base: 680x400 black
leg: 1050 black ring

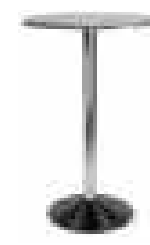

FLORIDA
index: 01S52B/105C
base: Ø 520 black
leg: 1050 chrome

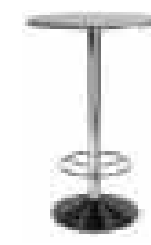

FLORIDA
index: 01S52B/105CR
base: Ø 520 black
leg: 1050 chrome ring



FLORIDA
index: 02S52B/105B
base: 520x520 black
leg: 1050 black



FLORIDA
index: 03S68B/105CR
base: 680x400 black
leg: 1050 chrome ring



FLORIDA
index: 04S59B/70B
base: 590x170 black
leg: 700 black



FLORIDA
index: 04S59B/105BR
base: 590x170 black
leg: 1050 black ring



FLORIDA
index: 04S59B/105C
base: 590x170 black
leg: 1050 chrome



FLORIDA
index: 04S59B/105CR
base: 590x170 black
leg: 1050 chrome ring

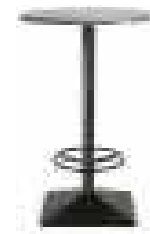

FLORIDA
index: 02S52B/105BR
base: 520x520 black
leg: 1050 black ring

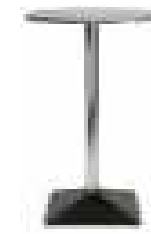

FLORIDA
index: 02S52B/105C
base: 520x520 black
leg: 1050 chrome



FLORIDA
index: 02S52B/105CR
base: 520x520 black
leg: 1050 chrome ring

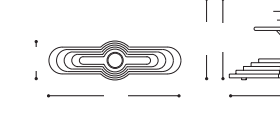
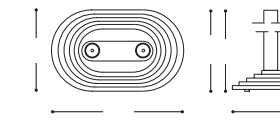
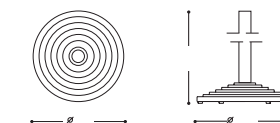
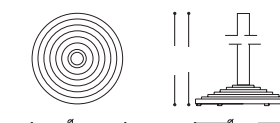
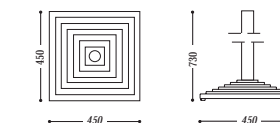
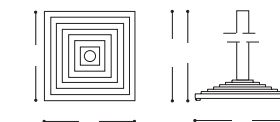

Metal elements
Finition tubes

alu

chrome

black

ACCESSORIES
ACCESSOIRES



KONTORSENTRET



A coat hanger made of a chromium plated metal tube and black metal foot. The hanger's crown is made of chromium plated rods with solid wooden round endings in beech colour.
 Portemanteau composé d'un tube chromé central et d'une base noire.
 Couronne du portemanteau en métal chromé avec embouts en bois massif coloris hêtre.



18 colored plastic hooks
 in beige colour
 18 crochets coloris beige



Metal elements
 Finition tubes

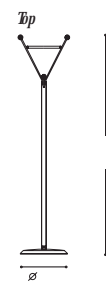

A coat hanger made of chromium plated or powder coated metal tubes with a chromium plated metal ring and plastic support for umbrellas.
 Portemanteau en métal époxy ou chromé,
 avec support parapluies en métal et égouttoir en plastique.



Arizona alu

Arizona black

Arizona chrome

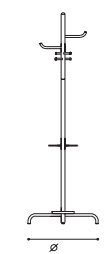

Metal elements
 Finition tubes



Rado - hanger - wall coat hanger made of powder coated metal rods.

Rado - portemanteau - structure en tube métal époxy



Rado chrome coat hanger

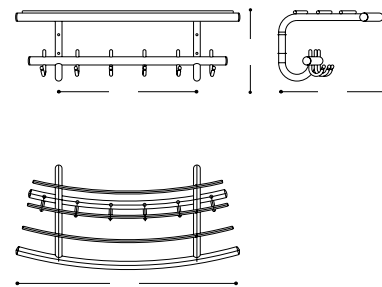

Rado - shoe shelf - shoe shelf made of powder coated metal rods. Available in two sizes.

Rado - étagère à chaussures - structure en tube métal époxy disponible en deux dimensions



Rado chrome shoe shelf (low version)

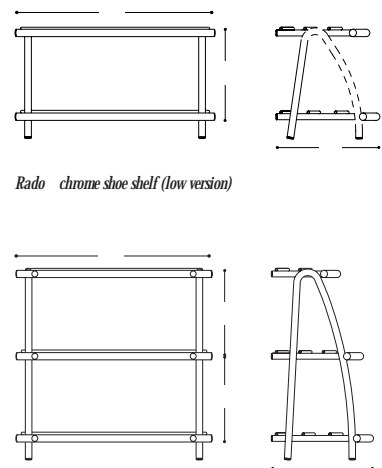

Rado chrome shoe shelf (low version)

Rado chrome shoe shelf (high version)

Polo - hanger - wall coat hanger made of powder coated metal rods. Available in two sizes.

Polo - portemanteau - structure en tube métal époxy disponible en deux dimensions



Polo alu coat hanger 600

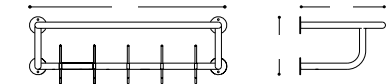

Polo alu coat hanger 600

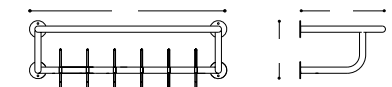

Polo alu coat hanger 800

Polo - shoe shelf - shoe shelf made of powder coated metal rods. Available in two sizes.

Polo - étagère à chaussures - structure en tube métal époxy disponible en deux dimensions



Polo chrome shoe shelf 600

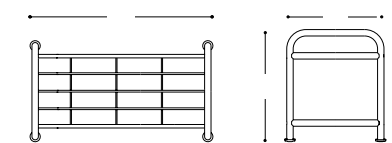

Polo chrome shoe shelf 600

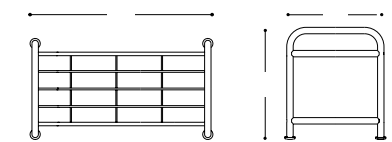

Polo chrome shoe shelf 800

Metal elements
Finition tubes



Metal elements
Finition tubes



Colorado

metal / métal

A coat hanger made of powder coated metal rods.
Portemanteau fabriqué en tubes métal époxy



Colorado alu coat hanger

Metal elements
Finition tubes

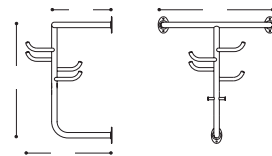

ø 60

Table bases matching the tops Bases des tables adaptables aux plateaux

SHAPES AND DIMENSIONS OF TOPS TABLES FORMES ET DIMENSIONS DES PLATEAUX POUR LES TABLES	TABLE BASES / BASES DES TABLES																												
	BISTRO TABLE	BISTRO TABLE 1100	CAFETERIA	CLAUDIA TABLE	DOLY TABLE 380	DONA - 3	DONA - 4	FLORIDA	GALA	KAJA	KARINA	LENA	LENA 1100	MELBA TABLE	MELBA TABLE 80	MELBA DUO TABLE	MILENA TABLE	MOLINO TABLE	MOLINO DUO TABLE	ROZANA	SONIA 740	SONIA 840	TIRAMISU TABLE	TIRAMISU DUO TABLE	TRACY	TRACY DUO	WIKTOR	WIKTOR 1100	
	TABLE TOPS / PLATEAUX DES TABLES werzalit®																												
ø 60	●	●●●			●●●			●●●	●●●					●															●●
ø 80	●		●●	●●	●●	●●	●●	●●	●●		●	●●		●	●	●													
ø 90	●			●●			●	●				●			●		●●●●	●			●								
80x80	■			●		●●	●●		●				●	●●●●	●														
110x70	■								●●																		●		
120x80	■								●●						●		●						●		●				
	GLASS TABLE TOPS / PLATEAU DES TABLES EN VERRE																												
ø 90	●																			●	●								
	TABLE TOPS MADE OF MELAMINATED CHIPBOARD (MA) / PLATEAUX DES TABLES EN MELAMINE (MA)																												
ø 60	●	●●●			●●			●●●	●●●					●														●●	
ø 80	●		●●	●●	●●	●●	●●	●●	●●		●	●●		●	●	●													
80x80	■			●		●		●●	●				●	●●●●	●														
120x80	■								●●						●		●						●		●				
	TABLE TOPS WITH NATURAL VENEER (ON) / PLATEAUX DES TABLES AVEC PLACAGE EN BOIS NATUREL (ON)																												
ø 60	●	●●●			●●			●●●	●●●					●														●●	
ø 80	●		●●	●●	●●	●●	●●	●●	●●		●	●●		●	●	●													
ø 90	●			●●			●	●				●			●		●●●●	●			●		●		●				
80x80	■			●		●		●●	●				●	●●●●	●														
120x80	■								●●						●		●						●		●				

The colours presented in the catalogue may differ from original ones.
Les couleurs de finition présentées dans notre catalogue peuvent varier légèrement par rapport aux couleurs réelles.

Products in alphabetic order:

Liste alphabétique des produits:

Adria Hocker	156	Harlekin Table	196
Alerto	120	Harpo	188
Amaro	118	Ibis	86
Amigo	128	Jola	148
Anca	58	Kaja	216
Arancia	100	Karina	217
Arancia 78	168	Kelly	88
Arancia Hocker	168	Kolibier	34
Argento	112	Lena 1100	224
Ascona	122	Lena	224
Azzurro	102	Malva	20
Azzurro 78	172	Marino	114
Azzurro Hocker	172	Medea	70
Baleno	50	Melba Duo Table	206
Baleno 78	146	Melba Table	206
Baleno Hocker	146	Mewa	30
Beta	124	Milena Table	198
Bingo	32	Molino	46
Bistro 1100 Table	204	Molino 78	142
Bistro	38	Molino Duo Table	202
Bistro 78	138	Molino Hocker	142
Bistro Hocker	138	Molino Table	202
Bistro Table	204	Neron	110
Cafe II	74	Neron 78	170
Cafe III	76	Neron Hocker	170
Cafe IV	78	Plenum	26
Cafe Table	220	Polyfold	126
Cafe V	80	Retro Hocker	178
Cafe VI	40	Rico Table	225
Cafe VII	82	Ringo	186
Caldo	92	Ringo Hocker	160
Caldo 78	162	Ristretto	72
Caldo Hocker	162	Rosso	106
Castano	116	Rosso 78	174
Chico	191	Rosso Hocker	174
Claudia Table	222	Rozana	214
Club	22	Salsa	24
Cortina	130	Salsa Wood	66
Deco	56	Samba	84
Dolce	48	Samba Wood	64
Dolce 78	144	Sonia	215
Dolce Hocker	144	Tiramisu Duo Table	208
Dolly	68	Tiramisu Table	208
Dolly Hocker	158	Tiziano	90
Dolly Stool	184	Tiziano 78	166
Dolly Table 380	212	Tiziano Hocker	166
Dona-3	218	Tracy	210
Dona-4	218	Tracy Duo	210
Dorino	36	Tulipan	62
Dorino Duo Table	200	Tulipan 78	154
Dorino Table	200	Tulipan Hocker	154
Elva	20	Vega	52
Fiamma	44	Vega 78	152
Fiamma 78	140	Vega Hocker	152
Fiamma Hocker	140	Vena	104
Florida	226	Vento	42
Fosca	54	Venus	60
Gala	213	Venus 78	150
Giallo	108	Venus Hocker	150
Giallo 78	176	Visa	94
Giallo Hocker	176	Wiktor 1100	221
Golf	132	Wiktor	221
Grappo	189	Wing II	28
Grigio	98	Zeppo	190
Grigio 78	164	Zeta	180
Grigio Hocker	164	Zeus	96
Harlekin	18		